



# Flame Detection

Application Manual

A photograph of an offshore oil rig at sunset. The sky is a mix of orange and yellow, transitioning into a dark blue over the ocean. In the foreground, there are large, dark metal pipes and structures of the rig. A person is visible on a platform in the middle ground. In the background, another smaller rig is visible on the horizon. The overall scene is industrial and serene.

*FLAMEVision* is a global Tyco brand for innovative detection technologies in special hazard applications and hazardous areas. The flagship FV300 flame detector provides industry-leading flame detection performance using IR Array technology to eliminate false alarms and provide positional data on the hazard. Integration of video cameras into the products also extends the applications to verification and remote-control solutions. *FLAMEVision* products provide a superior detection solution for industrial, petrochemical, oil and gas, pharmaceutical, and specialty applications. For more information, visit [www.tycofireddetection.com/FlameVision](http://www.tycofireddetection.com/FlameVision)

# Contents

<b>Introduction</b>	5
<hr/>	
<b>Background</b>	
<hr/>	
Electromagnetic radiation	6
Atmospheric radiation transfer	7
<b>Detector Technologies</b>	
<hr/>	
General principle	8
Radiation sources and Inhibitors	9
UV flame detection techniques	11
Single Channel IR detectors	12
UV/IR (single channel) flame detectors	14
Dual channel IR flame detectors	15
Triple channel IR flame detectors	16
Video image-based detectors	18
IR image-based detectors	20
<b>Fire Engineering</b>	
<hr/>	
Characteristics of fires	23
Combustion cycle	24
Hazardous Characteristics Solids, Liquids and Gases	24
Fire Classes	25
Class A fires	26
Class B fires	28
Class C fires (Europe)	30
Class D (combustible metals) fires	31
Class E (Electrical fires)	32
<b>Protection of Electronic Equipment</b>	
<hr/>	
Hazardous Area (zone) Classifications	33
Non-Hazardous Areas	34
Apparatus Gas Grouping	35
Temperature Classification	36
Types of Protection	38
Intrinsically Safe Barriers	39
Intrinsic Safety	41
Flameproof	41
Equipment Marking	42

# Contents

## Typical Flame Detector Applications

---

Dike / Storage Protection	43
Floating Roof Tank	45
General principles	45
Protection of floating roof tanks with rim detectors	45
Floating roof tank protection using overhead detectors	48
Fuel Transport Load Facility	50
Diesel Engine	51
Aircraft and Hangars	53
Wellhead Process Areas	57
Transformers	59
Robotic extinguishment	61
General principles	61
Fire detection for robotic suppression systems	62
Suppression systems	62
IR array based robotic extinguishing system	63

## FV300 IR Image - Based Flame Detector

---

General	66
FV300 operation principles	67
Other FV300 Features	70
Use in hazardous atmospheres	71
Typical applications and suitable detector models	71
FV300 Detector Variants	71
System design information	72
Mechanical construction	72
Environmental characteristics	74
Fire detection characteristics	75
False alarm immunity	78
Designing detection systems	78
Approvals, compliance with standards and patents	79
System design information	82
System interfaces	82
Electrical characteristics	82
Fire positioning solutions	86

**Figures:**

---

Fig 1: Electromagnetic radiation	6
Fig 2: Solar radiation/ Carbon dioxide absorption/ Emission Bands	7
Fig 3: Typical hydrocarbon fire spectrum	7
Fig 4: Radiation/Inhibitors/detectors	9
Fig 5: Mesh diagram showing the image projected on a 16 x 16 array of two real fire sources	21
Fig 6: Example of fuel tank storage fire	23
Fig 7: Typical Class A fire	26
Fig 8: Class A fire curve	27
Fig. 9: Typical Class B fire	28
Fig.10: Detection of Class B fires	29
Fig.11: Typical Class C fire	30
Fig.12: Typical Class D fire in a furnace	31
Fig.13: Typical Class E fire	32
Fig.14: Area (zone) Classification	33
Fig.15: IEC Apparatus Gas Grouping	35
Fig.16: Temperature Classification	36
Fig.17: Typical Zener barrier arrangement	39
Fig.18: Galvanic Isolator	40
Fig.19: Examples of EExd, Flameproof equipment	41
Fig.20: Equipment Marking	42
Fig.21: Dike Storage area (25-meter diameter tanks).	43
Fig.22: FV 300 cone of vision	44
Fig.23: 100-meter floating roof tank with FV300 IR image-based protection	45
Fig.24: Diagram showing rim seal coverage with FV300 Array IR Flame detectors	46
Fig.25: General arrangement for FV300 detectors on 100 m floating	47
Fig.26: 50 m floating roof tank with IR flame detectors centrally positioned above the tank	48
Fig.27: Example of 50 m diameter by 30 m deep tank protected with overhead detectors	49
Fig.28: Transport loading facility	50
Fig.29: Diesel Engine room	51
Fig.30: Aircraft hangar detector layout	53
Fig.31: Wellhead Process Areas	57
Fig.32: Example of oil-filled transformers	59
Fig.33: Example of oil-filled transformers room	60
Fig.34: Example of a deluge system operated in an oil-filled transformer room	61

# Contents

Fig.35: Robotic suppression system	62
Fig.36: Triangulation of FV300 flame detectors to control a firefighting monitor	64
Fig.37: FV300 CCTV with flame detection overlay	65
Fig.38: FV300 location and size information on the IR array	65
Fig.39: Test fire and extinguishment monitor in action	65
Fig.40: FV300 Series detectors general view	66
Fig.41: Example of array cluster	67
Fig.42: Measured spectral characteristics of a fire and a blackbody	69
Fig.43: FV300 Detector – General view	72
Fig.44: FV300 detector earth and tag fixing points	73
Fig.45: FV311 rear enclosure	73
Fig.46: FV312 rear enclosure	73
Fig.47: FV300 with weather hood	74
Fig.48: FV300 relative range v angle of incidence – horizontal plane	77
Fig.49: FV300 relative range v angle of incidence – vertical plane	78
Fig.50: View of FV300 label with Regulatory Markings	81
Fig.51: FV300 system interfaces	82
Fig.52: FV300 4 - 20mA current sink/source wiring diagrams	83
Fig.53: FV300 MODBUS line termination	84
Fig.54: FV300 Walk test input connection	85
Fig.55: FV300 Remote LED wiring diagram	86
Fig.56: 3D representation of flame position	87
Fig.57: Example of fire positioning system components	88
Fig.58: Examples of SKUM fire monitors	89

## Tables:

---

Table 1: Flashpoints of Flammable and Combustible Liquids	25
Table 2: Fire classes	25
Table 3: Area (zone) Classification Europe & North America	34
Table 4: Surface temperature classification in Europe and North America	37
Table 5: Types of Protection in Hazardous Areas	38
Table 6: Detection range over the detector field of view	76
Table 7: Detection range over the detector field of view	76
Table 8: FV300 immunity response to various false alarm sources	78
Table 9: Video output against temperature	85



# Introduction

This document is designed to assist anyone involved in selling, designing or specifying fire detection systems involving flammable materials. Specifically the document looks at the principles behind flame detection, the technologies available and their applications. The manual concludes with detailed data on the FV300 FlameVision IR image based flame detector that represents the state-of-the-art in flame detection for many of the applications discussed. It is intended that this manual be used as a reference document. The following section descriptions will help to rapidly locate relevant information.

**Section 2** looks at some of the background physics that are exploited by flame detectors and is useful when understanding the differences between different detector technologies.

**Section 3** looks at the different detector technologies that are available from single channel UV and IR detectors to multi-channel detectors and image based detectors, including video image and IR image technologies. The advantages and limitations of each technology are discussed.

**Section 4** provides an overview of fire engineering principles which may be known to many readers but which are important when applying flame detectors.

**Section 5** provides further background information on the classification of hazardous areas as well as the terms and terminology used. This is important in understanding the overall system application of flame detectors.

**Section 6** looks at a number of typical applications and the methodology behind the use of flame detectors in these applications. Applications covered include fuel storage, fuel transport, process areas and aircraft hangars.

**Section 7** provides more detailed information on the FV300 FlameVision IR image based flame detector. It covers the basic operating principles as well as the key features of the detector and also gives information on its mechanical construction, environmental characteristics and fire detection characteristics.

**Section 8** provides system design information that looks at the interfaces between the FV300 FlameVision and a central alarm monitoring system. This is essential information to enable optimum use of the functions and benefits offered by this sophisticated flame detector.

Full installation, commissioning and user instructions for the FV300 FlameVision IR image based detectors are available in user manual UM35 (Stock Code Number 120-415-886). Information specific to the S200+series Triple IR flame detectors can be found in user manual UM26 (Stock Code Number 120.415.400). Both manuals can be accessed from the Tyco Safety products Website [www.tycosafetyproducts-europe.com](http://www.tycosafetyproducts-europe.com).

# Detector Technologies

## Electromagnetic radiation

Electromagnetic radiation is a form of energy exhibiting wave like behaviour as it travels through space. Electromagnetic radiation is classified according to the frequency of its wave. In order of increasing frequency and decreasing wavelength, these are radio waves, microwaves, infrared radiation, visible light, ultraviolet radiation, X-rays and gamma rays (see Fig.1). The eyes of various organisms sense a small and somewhat variable window of frequencies called the visible spectrum.

The infrared radiation lies between the red end of the visible spectrum and the beginning of the microwave regions and covers the range from  $0.7\mu\text{m}$  to  $300\mu\text{m}$ .

Fig 1: Electromagnetic radiation

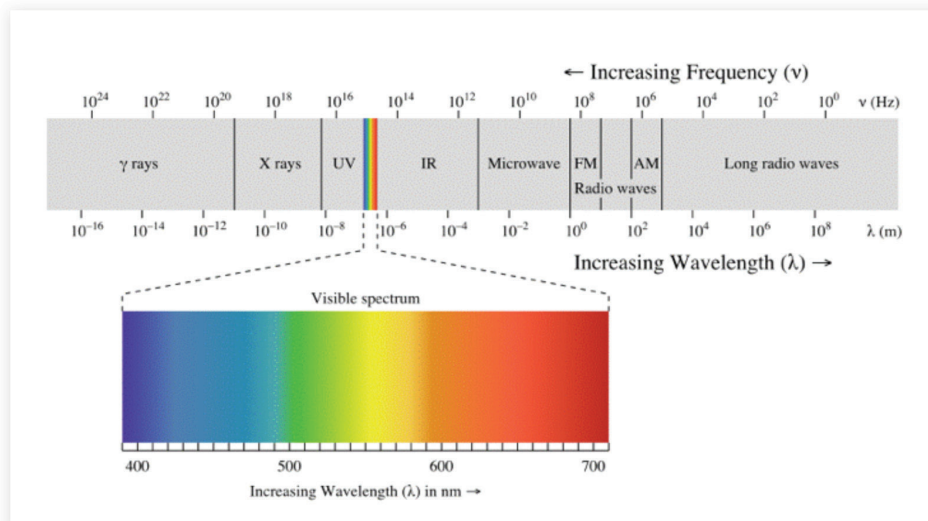

Different areas of the spectrum are produced in different ways. Changes in the configurations of molecules produce spectra in the visible, infrared, and ultraviolet regions. Changes in motions of the inner electrons of heavy atoms produce X-ray spectra, whilst changes in the configurations of the nucleus of an atom produce gamma-ray spectra.

The spectral band of radiation from infrared (IR) and ultraviolet UV) is of particular interest in the field of Fire Engineering. Components of UV and IR emitted from conflagrations, explosions, and combustion of material can be used for detection purposes. The process of combustion causes many molecular energy level transitions within the constituent molecules of the materials involved as they change between combinations of solids, liquids, and gases.

When the core structure of a molecule is altered using pressure, heat or oxidation, energy is released and radiates across the spectrum. When a molecule emits (or absorbs) energy, it can only emit a discrete amount i.e. one quantum, for a particular transition to occur. The energy from molecular transitions is related to the type of molecule involved. For example Carbon Dioxide, releases energy in the infrared spectrum, predominantly at the  $4.3\mu\text{m}$  wavelength when heated. This property is specifically used for infrared flame detection techniques.



## Atmospheric radiation transfer

When the core structure of a molecule is altered using pressure, heat or oxidation, energy is released and radiates across the spectrum. When a molecule emits (or absorbs) energy, it can only emit a discrete amount i.e. one quantum, for a particular transition to occur. The energy from molecular transitions is related to the type of molecule involved. For example Carbon Dioxide, releases energy in the infrared spectrum, predominantly at the 4.3  $\mu\text{m}$  wavelength when heated. This property is specifically used for infrared flame detection techniques.

*Fig 2: Solar radiation/ Carbon dioxide absorption/ Emission Bands*

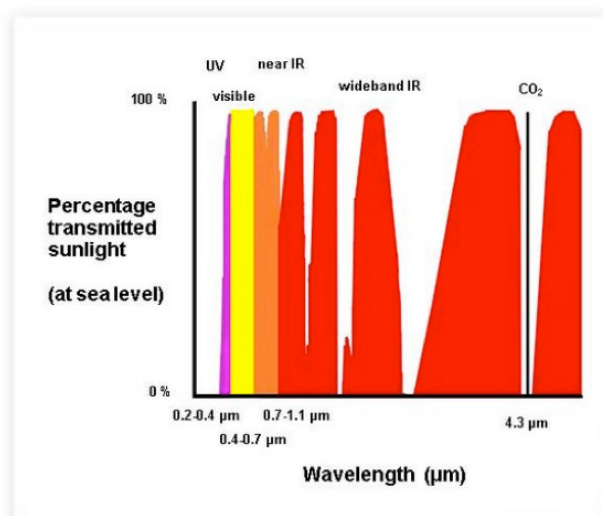

The sun radiates enormous amounts of energy across the electromagnetic spectrum (see Fig.2). Most of this energy is absorbed by the atmosphere and converted into Ozone. Incident UV radiation occupies a band around 0.2 microns. This band is termed "solar blind" as a UV sensor operating within it will not be affected by UV radiation from the sun. IR sensors require additional techniques to become solar blind. When organic material burns, (see Fig.3), large amounts of hot CO<sub>2</sub> are produced. Thus any fires involving hydrocarbon results in a peak emission of energy

at 4.3 microns. This peak emission also corresponds (Fig.2) to a high atmospheric absorption band of solar radiation. This atmospheric absorption similarly affects the radiation emitted from a carbonaceous fire, limiting the effective range of IR flame detectors based on sensing the CO<sub>2</sub> peak emission. However because of the reduced solar radiation reaching the surface of the earth at this wavelength a better signal discrimination can be achieved. These characteristics have been exploited by IR flame detector designers over the years.

*Fig 3: Typical hydrocarbon fire spectrum*

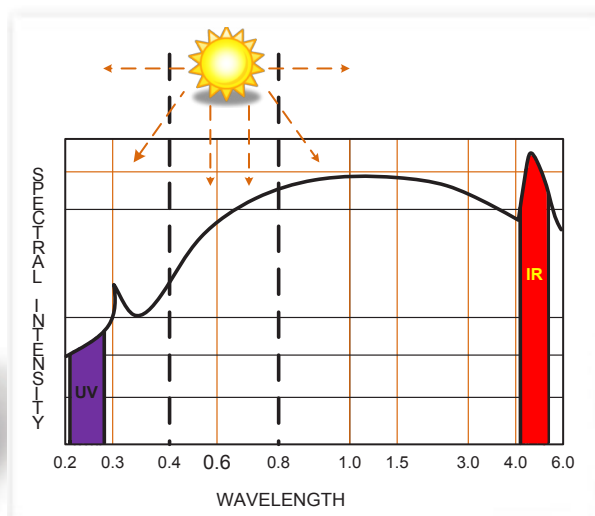

IR detectors generally incorporate optical lens and filter arrangements, with a band pass filter operating at 4.3 microns making the IR detector blind to solar radiation. More sophisticated filtering techniques and/or selected electronic signal processing is used in the design of the latest, multi-channel infrared flame detectors to reduce false alarms further. Some Infrared detectors are tuned to respond to the H<sub>2</sub>O emission band by using an infrared sensing channel tuned to 2.9  $\mu\text{m}$ . Doing so can enable these detectors to detect fire from non-hydrocarbon based materials.

# Detector Technologies

## General Principle

This section looks at the different technologies available for flame detection, their similarities, limitations and relevant advantages.

Most flame detectors are optical, electronic sensors, tuned to operate and respond to UV and/or IR radiation, which is outside the visible solar spectrum. There is commonality between UV and IR in the following areas:

i) They are both “line of sight devices”. The input radiation has to be optically viewed for the sensor to respond. A typical sensor cone of vision is  $\pm 45^\circ$  measured from the detector’s direct line of sight (tangent).

ii) Radiation is transmitted at the speed of light; hence flame detectors are the preferred detection devices for early warnings in high risk applications that may also involve fire extinguishing and explosion suppressant systems.

iii) Detectors are tuned to selected bandwidths. The sensor’ lens/ band-pass filter allows radiation to be received at the detector only at a selected narrow frequency band.

iv) Radiated power received is proportional to the radiation source and inversely proportional to the distance squared:

$$\text{Power radiated (PR)} = \frac{\text{Size of radiation (Pan Fire)}}{\text{Distance squared (D}^2\text{)}}$$

Thus a radiation sensor will sense a 1 sq ft. pan fire at a distance of 20 ft. If the distance is increased to 40 ft the pan fire will have to increase to 4 sq ft. In practice most radiation detectors are designed to detect modulated energy in a limited range of frequencies (typically 1 to 20 Hz). Modulated energy and hence the performance of a radiation detector does not follow this equation. Actual detector performance will vary according to the manufacturer and the algorithms used.



## Radiation sources and Inhibitors

In understanding the differences between the detector technologies it is important to understand not only the sources of different radiation but also the materials and circumstances that can inhibit the radiation source. Knowledge of the likely inhibitors in an application is important when designing flame detection systems. The different radiation sources and inhibitors that have to be considered are shown in Fig.4 and discussed in this section.

Fig 4: Radiation/Inhibitors/detectors

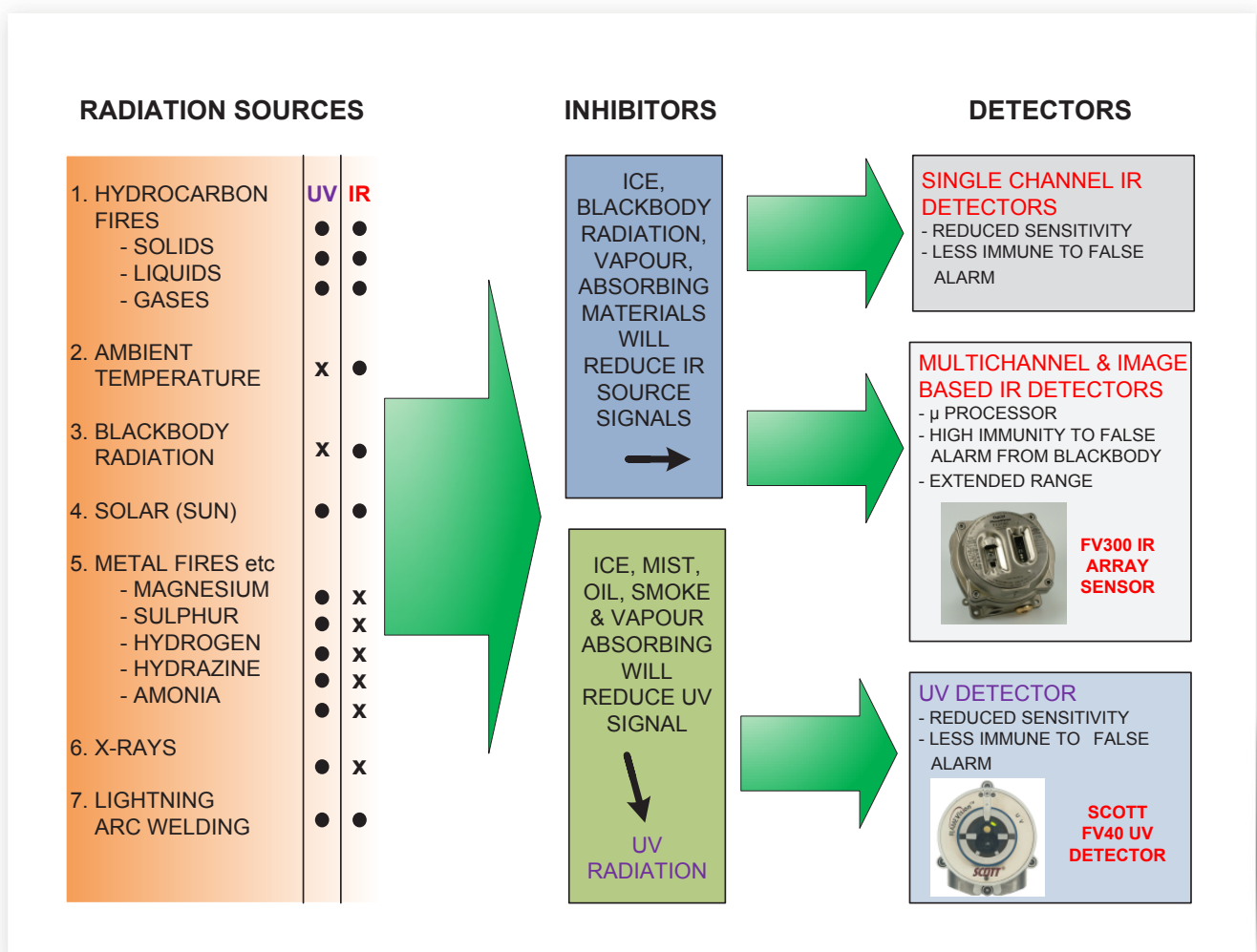

## Radiation sources

The origin and the type of radiation that is emitted, whether it is UV or IR, comprises:

**1) Fires:** Fires are a rich source of UV and IR radiation. The combustion of hydrocarbon produces IR, peaking at 2.7 μm and 4.3 μm (see Fig.4). 4.3 μm is the CO2 peak emission band and is caused by hot carbon dioxide emitted during the hydrocarbon combustion process.

Hydrogen and metal fires, which are non- organic, produce IR at 2.7μm and UV at 0.1-0.35μm but no IR radiation at the 4.3μm peak used by IR flame detectors.

# Detector Technologies

## Radiation sources

**2) Ambient temperature:** Temperature relates directly to the amount of IR radiation emitted. All objects with a temperature in excess of 0C Kelvin (-273°C) radiate IR energy due to molecular movement. Ambient temperature values and the ambient temperature profiles will vary for every detector location.

**3) Blackbody radiation:** Blackbody radiation is a heat energy which emits radiation due to a temperature differential between the source and its surroundings. Solar energy at the surface of the earth contains little IR radiation at the IR 4.3 µm band due to the atmospheric absorption in the CO2 peak emission band. However, solar energy can heat objects that will then radiate what is then termed “blackbody radiation” at 4.3 µm.

**4) Solar radiation:** The sun radiates energy across the electromagnetic spectrum, and is an enormous source of UV and IR radiation (See Fig. 3).

**5) Metal Fires:** In general, metal fires will generate UV radiation with a negligible amount of IR radiation. Other non-carbon fires will also generate UV as shown below:

	UV	IR
Hydrogen	Yes	No
Sulphur fires	Yes	No
Magnesium	Yes	No
Ammonia	Yes	No

**6) X-ray and gamma radiation:** These are fast particles travelling below the speed of light. Both types of radiation have the ability to penetrate flame detector housings. With a UV detector, this radiation may cause the detector to function in a manner similar to when initiated by UV radiation. In some instances, this can give rise to false alarms with UV detectors.

### 7) Lightning / Arc Welding:

(i) **Lightning, the richest source of UV radiation,** is the product of atmospheric disturbances and electrical storms. An electrical arc discharging to earth, can flash from cloud to cloud ionising the atmosphere, the abundant UV will trigger and activate sensors and initiate a series of false alarms. Detectors designed for outdoor use are normally compensated with an internal time delay of 3 seconds or more to override the lightning time duration. This also clearly reduces the response time of the detector.

(ii) **Arc welding is a primary source of UV radiation.** It is a frequent source of false alarms, caused by the initiation of an electric current discharging to produce an electric arc. The arc mechanism produces “high transients” switching signals right across the frequency spectrum. The welded area reaches temperatures of 3,500 °C. The heated metal forms a secondary source of IR radiation. IR detectors, although more immune to false alarm from welding sources, can still give false alarm indications if the welding process is carried out in relatively close proximity to the detector and the detector does not include other mechanisms to protect it from such false alarm sources.

There are external influences, whose presence can have a detrimental effect on the ability of the detector to see flame radiation (see Fig.4). These items are chemical vapours and gases, known as inhibitors; they have the ability to absorb radiation. Their presence within the detectors' cone of vision can nullify or reduce the input from fire radiation, rendering the detector inoperable. Likewise a soiled window lens, oil, mist, ice, water, smoke will impair the radiation signal to the line of sight device.

## UV flame detection techniques

### Detection principles

Detectors that operate under the principle of sensing UV have been around in the market place around 30 years. UV detection technology has probably not evolved as far as IR detection technology over the same period of time. Whilst there are some applications which are still most suited to UV detection the previous discussion highlights some serious limitations due to the fundamental principles of detection.

### Advantages

**Solar Blind** - The effect of ozone in the atmosphere of the earth is such that it absorbs incident UV radiation from the sun. Ozone tends to absorb UV radiation of lower frequency and so UV flame detector transducers are able to operate in an area of the waveband where there is little to no ambient UV radiation present. The detectors are therefore inherently solar blind.

**High temperature** - The main advantage for detectors, which utilise UV detection principles, is their resistance to give false alarms from high temperature heat sources. Special UV flame detectors are available, which can operate at an ambient temperature of approximately 110° C. However, these special high temperature detectors are relatively expensive.

**Metal based fires** - The detection principles make them suitable for the detection of both hydrocarbon fires and less common, metal based fires.

**Fast operation** - The detectors can operate very quickly, but the ability to do so may increase the number of false alarms from the device. False alarms cost money and can result in loss of confidence in the fire detection system. The advantage of speed with these detectors can be exploited, if precautions are taken to minimise interference from external false alarm sources.

# Detector Technologies

## UV flame detection techniques

### Limitations

**False alarm sources** - UV detection methods are sensitive to arc-welding, electrical arcs, X-rays and lightning. Although it is possible to eliminate false alarms from lightning and electrical arcs by the inclusion of additional time delay processing in the detector circuitry, elimination of false alarms from Arc welding and X-rays is much more difficult to achieve. The detector's sensitivity to these false alarm sources can be a significant problem.

**UV inhibitors** - The main inhibitors of UV propagation are oil mists or films, smoke and principally heavy dark smoke, hydrocarbon vapour and water films or ice. All of these phenomena can significantly reduce the intensity of the UV signal if present in the flame detection path.

**High Current** - The sensing elements used by UV detection methods require relatively high currents and thus it is not practical to design intrinsically safe variants.

**Failure Modes** - UV detectors can sometimes have characteristic failure modes. For example, they can become sensitive to ambient light or solar radiation, or break into free oscillation ("runaway"). The detector tube can become insensitive or the tube circuit can malfunction.

## Single Channel IR detectors

### Detection principles

The combustion of hydrocarbons typically produces the characteristic in the hydrocarbon fire spectrum as indicated in Fig.3. The two main peaks occur at  $2.7\mu\text{m}$  (radiation emitted by water vapour) and  $4.3\mu\text{m}$  (radiation emitted by  $\text{CO}_2$ ).  $\text{CO}_2$  in the atmosphere of the earth absorbs infrared radiation at this later frequency.

IR flame detectors can respond to solar radiation permeating the earth's atmosphere and it is therefore important that infrared flame detectors are designed to such an extent that they are completely solar blind.

Non-hydrocarbon fires such as metal fires do not produce  $\text{CO}_2$  in the combustion process. Such fires are in general better suited to IR flame detectors operating at the  $2.7\mu\text{m}$  wavelength.

IR flame detectors are often able to capitalise on another phenomenon of fire i.e. flame flicker. The determination of flame flicker allows an IR flame detector to reduce the probability of giving a false alarm in the presence of blackbody radiation. Although the ability to determine the flicker characteristic is essential for an infrared flame detector, it is not enough on its own to reduce a detector's ability to detect false alarms. Most single channel flame detectors detect flame flicker within a 1 Hz to 20 Hz waveband.

## Advantages

**Solar blind** – Most single channel infrared detectors now on the market are solar blind using techniques such as Thorn Security's patented filtering technology used on the S100 series of flame detectors.

**Reasonable false alarm immunity** – IR detectors are generally immune to arc-welding and X-rays. Flicker analysis of the radiated signal received by the detector is designed to eliminate false alarm from steady blackbody sources. This type of detectors can be prone to false alarm in the presence of modulated blackbody, specifically those with high intensity. This can be minimized effectively by correct siting of the detector and reducing its overall sensitivity or range.

**Low current** – IR detectors can be designed that uses very low power. This allows these detectors to be used in intrinsically safe (IS) circuits when protecting hazardous areas involving hydrocarbon fuel.

**Cost** – Low cost single channel IR detectors are available but have limited applications, especially following the development of detectors using multiple sensing channels as described further down.

## Limitations

**Solar Blindness** - Single channel IR flame detectors that do not employ specific radiation filtering techniques are not solar blind. This restricts their use to indoor environments where there is no direct sunlight or reflected sunlight in the optical path of the detector.

**Blackbody Radiation** - The sensitivity of single channel IR detectors can be influenced by the introduction of modulated blackbody radiation into the field of view of the detectors, leading to possible generation of false alarm conditions. Such sources could be from powered equipment which generates sufficient heat to cause the problem. Other conditions can arise from human or other movements in the field of view of the detector.

The normal operating principle of the flame detector is such that the detector responds to relative changes in IR radiation, and thus a large IR source that does not flicker may mask an IR source that does flicker. Hence, a real fire condition could be missed under these conditions.

**Limited Range** – Due to potential risk of false alarm risks, the sensitivity and hence the range of single channel IR flame detectors is limited. This range can be further restricted by the introduction of contaminants on the window of the detector.

**No window test** - Single channel IR flame detectors typically do not provide any means of monitoring the cleanliness of the window and, so, the effectiveness of the detector may go unchecked between routine servicing.

# Detector Technologies

## UV/IR (single channel) flame detectors

### Detection principles

Combining the technologies of single channel UV and IR detection methods can alleviate some of the problems, but combined sensors can still have limitations. Each application needs to be analysed so that the best available detection combination can be selected.

UV/IR detectors contain two sensors and give an alarm only when both UV and IR are detected, thus eliminating many of the causes of false alarms. Unfortunately, they are also blinded by everything that blinds either UV or IR which results in reduced reliability.

### Advantages

**Fewer false alarms** - The UV/IR sensors can result in the elimination of false alarms from a single source, whether it is IR or UV. To minimize this risk, the UV/IR detectors can often have a number of pre-set configuration options to tailor the detector to suit typical applications.

### Limitations

**Complex System Design** - Application of the detectors requires careful consideration. System designers must account for all the possibilities of single source excitation from false alarm sources. Once these are established, they must then try to ensure that neither of these single sources occurs at the same time. This may be difficult to predict.

**High False Alarms (in some applications)** - If the detector has to be programmed not to give an alarm indication because of the presence of an unwanted UV or IR source, the detector will tend to behave like a single technology channel detector. For example, in an aircraft hangar where welding or X-rays are being used, the UV sensitivity may have to be reduced to increase the reliability of the detector. The action of reducing a detector's UV sensitivity may make the device behave like a single channel IR flame detector.

**Limited Range** - The maximum flame detection range of UV/IR flame detectors is limited by that of the lowest sensitivity technology. In addition, consideration needs to be given to the effect of any inhibitors that may affect the transmission of radiation, specifically in the UV waveband. Generally, the range of a detector will have a significant influence on the number of devices required to provide adequate detection coverage of a space.

**High Cost** - UV/IR flame detectors carry the inherent costs of the two sensing technologies used and are likely to be more expensive than flame detectors using a single technology.



## Dual channel IR flame detectors

### Detection principles

Single channel IR flame detectors process the received signal to determine the flicker content. Most flames flicker during the burning of organic and hydrocarbon based fires which have a regular supply of oxygen. If the flicker content is caused by something other than a genuine fire source, for example a modulated blackbody source, a single channel IR detector may give a false alarm. In order to overcome this problem, dual channel IR detectors are designed with an additional IR sensor. This additional sensor is tuned to a frequency that measures the background IR radiation level within the field of view of the detector. This second sensor does not respond to emission in the peak CO<sub>2</sub> flame detection waveband. Using signal-processing techniques, the signals from the two sensors are correlated such that the detector responds only if a true alarm condition is present.

Typical parameters used in these detectors are:

- i) Ratio of the reference sensor to the CO<sub>2</sub> emission band sensor;
- ii) Correlation between the sensors;
- iii) The relative amplitude of received signal from each sensor;
- iv) The flicker frequency of each sensor.

### Advantages

**Low false alarms** – Dual channel IR flame detectors produce fewer false alarms than either single channel UV or IR detectors. Dual channel IR flame detectors are generally immune to arc welding and X-rays. They are normally solar blind and use flame flicker analysis to reduce false alarms from steady blackbody sources.

**Low power** - Dual channel IR flame detectors typically require lower power than detectors using UV technology. This reduces installation costs and allows intrinsically safe variants to be produced such as the Thorn Security S200 Series.

**Low cost** - The absence of UV detection technology and low power consumption enable lower cost de

**No window test** - Single channel IR flame detectors typically do not provide any means of monitoring the cleanliness of the window and, so, the effectiveness of the detector may go unchecked between routine servicing.

### Limitations

**Detection Range** - The increased resilience of dual channel IR flame detectors against false alarm sources enables to be set to a higher sensitivity and, hence, they offer a greater detection range than single channel IR.

# Detector Technologies

## Dual channel IR flame detectors

### Limitations

**Loss of sensitivity (in some applications)** – As the dual channel IR detector offsets the signal received on the background channel from that received on the flame detection sensor, background a loss of detector sensitivity may be experienced in some applications where a high background signal is present.

These include:

- i) Difficulties for the detector to determine the difference between hot background IR sources and relatively cold background sources due to the choice of frequency for the second (background) sensor
- ii) A large blackbody source, which does not flicker, may mask a smaller source that does flicker. There is possibility that a real fire condition may not be detected under these conditions.
- iii) People in close proximity to the sensor can adversely affect detector performance as the detector may interpret the natural heat of the body as an infrared source. The detector may also detect the movement of people as a flicker characteristic. The overall result could be a false alarm condition.
- iv) A very smoky fire, with low flame content may be seen as a large blackbody which may swamp the CO<sub>2</sub> emission band sensor, and the detector may fail to produce an alarm condition.

**Metal and non-organic Fires** - Dual channel IR flame detectors are not suited for the detection of metal or non-organic fires.

**High temperature** - Like other IR detectors, dual channel IR flame detectors are not suited to the extreme temperatures that some UV sensors can operate in. Normal maximum continuous operating temperatures are between 70°C and 80°C.

## Triple channel IR flame detectors

### Detection principles

Triple channel IR flame detectors monitor the infrared spectrum at three chosen frequencies. One-sensor monitors the CO<sub>2</sub> emission band at 4.3 μm. The other two frequencies are used to monitor the background infrared level. They are normally chosen at frequencies on either side of the CO<sub>2</sub> emission band. The main objective of using the two background frequencies on either side of the emission band is to allow the detector to more accurately predict the amount of blackbody radiation present in the field of view.

## Detection principles

The two background sensor technique enables triple channel IR flame detectors to account for the differences in hot and cold blackbody radiation present - a function that cannot be accurately predicted by dual channel IR detectors. It also enables triple channel IR flame detectors to more easily detect fires in the presence of blackbody radiation. In triple channel IR flame detectors, the signals from the three sensors are correlated and, using signal-processing techniques, the detector decides if a true alarm condition is present.

Typical parameters used in these detectors are:

- i) Ratio of the reference sensors to the CO<sub>2</sub> emission band sensor.
- ii) Correlation between the sensors.
- iii) The relative amplitude of received signal from each sensor.
- iv) The flicker frequency of each sensor

## Advantages

**Very low false alarms** - Triple channel IR flame detectors typically produce fewer false alarms than any of the other detectors discussed. They are solar blind, immune to arc welding and X-rays and generally provide much better performance in the presence of both steady and modulating black bodies, both hot and cold.

**Longer range** - The range of triple channel IR flame detectors is increased substantially compared to that of other IR technologies. This reduces the number of detectors required to give the necessary coverage for a given space.

**Latest technology** – Typically, as triple channel IR flame detectors use the latest microprocessor technology, more self checking and testing routines are included. The detectors can thus alert the control system of an increased number of possible detector status conditions such as fire alarm, pre-alarm, electronics fault, dirty window fault.

The new detector technologies employed also provide increased RFI protection to meet more stringent current and future requirements.

**Low power and cost** - As with all IR detectors triple channel IR flame detectors inherently use low power and have low manufacturing cost that help reduce overall installation costs.

## Limitations

**Metal and non-organic fires** – Like single channel IR and dual channel IR flame detectors, triple channel IR flame detectors operate in the CO<sub>2</sub> peak emission waveband and, hence, are not suited for the detection of metal or non-organic fires.

# Detector Technologies

## Video image-based detectors

### Detection principles

The rapid development of digital electronic in the 1990s gave birth to the concept that smoke and/or flames from fires could be detected by a visual system where the information from an image could be digitized and analyzed by powerful digital signal processors (DSPs). In such systems each separate element of the image (pixel or group of pixels) can be analysed for dynamic changes and the resulting signal compared, using sophisticated algorithms, against knowledge based signatures of the development of fires and non-fire signals.

This has given rise to a new generation of flame detectors designed around CCD camera chips or using standard commercial CCTV cameras linked to central computers for the processing. Self-contained detectors built around a CCD camera are intrinsically better suited to the petrochemical industry as they generally offer better reliability and can be easily packaged in explosion proof housings.

The CCD camera used in the video image-based detectors operates in the visible spectrum; though this operation can extend partially into the lower IR wavelengths. These types of detectors are not able to take advantage of the optimum peak CO<sub>2</sub> flame emission (4.4  $\mu\text{m}$ ) and the maximum absorption of solar radiation when analysing radiation

### Advantages

**Very low false alarms** – Video image-based detectors because they use sophisticated algorithms to dynamically analyse changes in the monitored image have a greater ability than any of the other technologies previously reviewed to reject signals that do not indicate the characteristic of a flame. This makes them better at discriminating real fires from unwanted alarms from non-fire sources such as blackbody, specifically modulated blackbody.

**Situation awareness** – The use of CCTV technology enables real-time images to be transmitted to facility operators thus assisting in the rapid identification of the location of any incidents. Operators are able to get a truer understanding of the locality and scale of the problem and are better able to decide the most appropriate action required to deal with a particular event. This spatial awareness of the detector can also be used to mask 'friendly' fires such as process relief flare or their reflections from shiny structures.

**Latest technology** – Typically, video image-based detectors, by using the latest microprocessor technology, are able to carry out more self checking and testing routines than older technologies. The detectors can thus alert the control system of an increased number of possible detector status conditions including early warning of a developing fire situation and electronics faults.

## Limitations

**Range limitation** – Although the video image-based flame detection technology, when correctly implemented, can be said to increase the reliability of flame detection, it has a number of shortcomings that have to be carefully considered in any system design. Foremost, video image based flame detectors, because they operate in the visible spectrum, as they operate principally in the visible spectrum, are subject to being blinded by strong lighting including direct sunlight. Also, they can be severely masked by atmospheric borne contaminants such as mist, and vapour clouds. Practically this limits the effective range of detection, a factor that needs to be taken into account when designing systems.

**Specific false alarm situations** – As described above, video image-based flame detectors rely solely on algorithms applied to the visual image to discriminate real fire signals from other non-fire sources such as modulated sun and black body radiation. The algorithms are applied to the visual image to discriminate real fire signals from other non-fire sources such as modulated sun and black body radiation. Hence, there is a specific risk with this types of detectors that unwanted alarms may be caused by natural air movements such as may be generated by raising air plume from heated surfaces of sunlight shimmering on shiny surfaces.

**Complex detector set up** – Algorithms used by video image-based detectors generally rely upon accurate set up of various parameters. Knowledge based signatures of the development of fires and non-fire signals employed by these detectors require a period of learning in actual environment that needs to be carefully planned before the detector can be fully and confidently commissioned. If this is not done operators may experience difficulties with the system and lose confidence its ability to perform.

**Higher power and cost** – Video image –based flame detectors, due to their use of high speed powerful DSP processors consume significantly more power than the more conventional IR detectors, including triple channel IR flame detectors. They are also electronically more complex and more expensive.

**High temperature** - Like other IR flame detectors, triple channel IR flame detectors are not suited to the extreme temperatures in which UV sensors can operate. Normal maximum continuous operating temperatures of triple channel IR flame detectors are between 70°C and 80°C.

# Detector Technologies

## IR image-based detectors

### Detection principles

The analysis of the IR image of the flame, i.e. its thermal signature, brings a further improvement to the reliability of flame detectors compared to that achieved with the previously mentioned discrete sensors or the video image-based detectors.

Typically, IR image-based flame detector incorporates an array of sensors tuned to respond to IR radiation across a wide spectrum. With currently available technology, it is possible to use 16 x 16 sensor arrays giving 256 separate sensing elements, or image pixels. As further advances in semiconductor technology are made and as the cost of components and manufacturing processes decrease, affordable IR arrays with a greater number of elements will become available giving. These will provide the possibility for increased image resolution and better overall detector performance.

Each element of the array has a unique field of view so the effect is akin to having a large number of separate flame sensors, each capable of identifying the presence of an IR source within its field of view. The IR image-based flame detector can be considered like an IR video image-based detector that is able of dynamically analyzing changes in the IR image projected on the sensors array, using complex algorithms to track each source individually and assess the likelihood of each being a fire.

Advanced signal processing software within the detector analyses the whole array to identify the number and size of each IR source projected on the array. A source of infrared radiation such as a fire or a blackbody source could be any size and at any distance from the detector, so that it will occupy a varying part of the field-of-view and affect one or more elements of the array depending on its size and position vis-à-vis the detector.

For example, a visual image of what may take place in the array is represented in the mesh diagram in Fig. 5. Here, the two spikes in the mesh diagram indicate where IR activity is occurring across a number of infrared elements. The algorithms track the interaction of the various cells within the active signal spikes until they decide a fire condition has been reached and signal an alarm. Fig. 5 also clearly demonstrates how array-based flame detectors are able to track and detect more than one event within their field of view

### Advantages

**High sensitivity** – IR image-based flame detectors, detect IR radiation in the CO<sub>2</sub> peak emission spectrum of flames. Because of this they offer high sensitivity similar to those offered by the most sophisticated triple channel IR flame detectors. Like for these types of detectors, ranges depend on the fuel and size of fire but can be in excess of 60 m for a 0.1 m<sup>2</sup> n-heptane pan fire.

**Very low false alarm rate** – IR image-based flame detectors by combining the spectral analysis of the IR signal received with dynamic analysis of the individual signals from each image pixel offer the lowest unwanted alarm risk as any of the technologies reviewed so far.

**Wider field of view** – When designing flame detection system one important parameters is the space that can be monitored by a single detector as this typically determines the number of detectors that will be required. The detector coverage space is a function of both its range and its field of view.

*Fig 5: Mesh diagram showing the image projected on a 16 x 16 array of two real fire sources*

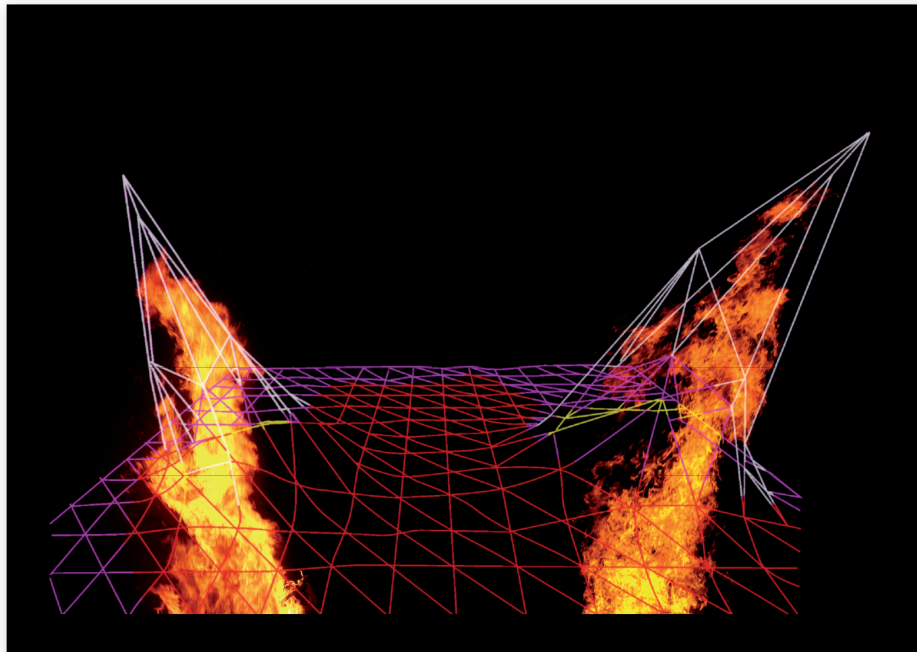

The use of an array of sensors means that the range and field of view of the IR image-based flame detector, such as the FV300, is consistent across the field of view unlike UV/IR or triple channel IR detectors where the range reduces as the target moves away from the axis. The lens, mounted above the array, is specifically designed to project a part of this field of view onto the array such that each element (pixel) of the array is looking at a particular area. As all of the pixels have the same ability to detect IR this means that the sensitivity is the same over the whole field of view.

**Multiple event detection** – A source of infrared radiation such as a fire or a blackbody source could be any size and at any distance from the detector, so that it will occupy a varying part of the field-of-view and affect one or more elements of the array depending on its size and position vis-à-vis the detector. Hence, as shown in Fig.5, image-based flame detectors are able to track and detect more than one event within their field of view.

**The ability of IR image**-Based detectors to analyze simultaneously more than one IR radiation signal in the field of view enable these detectors to better discriminate from real flame events and non-flame events. Furthermore it enables the detection and location of more than one fire event at any given time giving facility managers more precise information of a developing fire situation.

# Detector Technologies

## IR image-based detectors

### Advantages

**Situation awareness** – By combining the IR image of a fire with the CCTV picture of the scene, IR image-based flame detectors enable real-time images to be transmitted to facility operators thus assisting in the rapid identification of the location of any incidents. Operators are able to get a truer understanding of the locality and scale of the problem and are better able to decide the most appropriate action required to deal with a particular event. This spatial awareness of the detector can also be used to mask 'friendly' fires such as process relief flare or their reflections from shiny structures.

**Latest technology** – Typically, video image-based detectors, by using the latest microprocessor technology, are able to carry out more self checking and testing routines than older technologies. The detectors can thus alert the control system of an increased number of possible detector status conditions including early warning of a developing fire situation and electronics faults.

**Wider field of view** – When designing flame detection system one important parameters is the space that can be monitored by a single detector as this typically determines the number of detectors that will be required. The detector coverage space is a function of both its range and its field of view.



# Fire Engineering

This section looks at different types of fire from a Fire Engineering perspective and discusses how fires are classified and detection methods applied to different classification of fires. Fig.6 illustrates the kind of fire incident that can occur in fuel tank storage.

*Fig 6: Example of fuel tank storage fire*

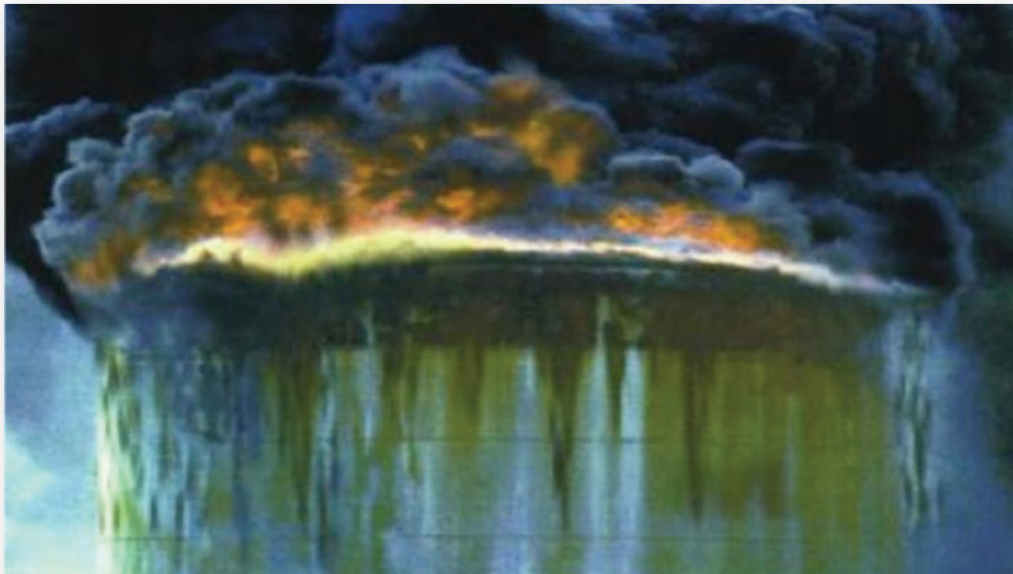

## Characteristics of fires

Fire is a chemical reaction between atoms such as Carbon, Hydrogen and Oxygen, resulting in the release of heat energy.

### Oxidation

Oxidation is a chemical process in which an element or compound combines with oxygen e.g. tarnish on silver, the rusting of iron.

### Fire combustion

Combustion of solids, liquids and gases results in the release of heat energy. Heat is emitted, in the most part, as infrared radiation. The transfer of this energy is normally by three methods:

1. Conduction which as the name suggests is transference of heat within solids and liquids.
2. Convection which is caused by the expansion of heated air. Heated air occupies a larger space and becomes lighter than the surrounding atmosphere. The lighter air rises and causes air currents, which carry the heat, hot gases and fire products.
3. Radiation which happen when changes in the configurations of molecules produce energy in the visible, infrared, and ultraviolet spectra.

During combustion, fire aerosols (particles) ranging in size from 0.001 to 10,000 microns are also released. Gases are also produced, the nature of which are dependent upon the combustion materials. Combustion gases generally exhibit a combination of characteristics; they can be hot, flammable and/or toxic.

# Fire Engineering

## Combustion cycle

The combustion cycle consists of the oxidation of vapour molecules, which then break apart, recombining with oxygen. The heat causes expansion, the burning product rises, allowing fresh replenishment of air and oxygen. A continuous feedback cycle is created, until the material (fuel) supply is oxidized, consumed and exhausted. This process gives rise to the phenomenon of flame flicker. As discussed in Section 3, Infrared detection devices can be programmed to recognise this flicker characteristic, which for hydrocarbon fuel is normally within the limits of 1 to 20 Hz.

## Hazardous Characteristics Solids, Liquids and Gases

Matter must be in the gaseous or vapour stage for combustion, oxidation and, hence, fire to occur. Solids must be exposed to sufficient heat, such that gaseous vapours are emitted from surfaces. It is these vapour which are able to combust and thus start a combustion cycle. The following characteristics of solids, liquids and gases are important when looking at the fire detection applications in hazardous areas:

**Flash Point:** The minimum temperature of a liquid at which sufficient vapour is given off to form an ignitable mixture with air, near the surface of the liquid or within the vessel used, as determined by the appropriate test procedure and apparatus specified in 1-7.4. [NFPA 30 1-7.2]. Table 1 gives the flash point temperature for selected flammable and combustible liquids.

**Flammable:** Flammable (Explosive) Limits are range bands where gas air mixtures if ignited, will just propagate flame. These limits are known as “Lower and Upper Flammable or Explosive Limits”. They are usually expressed as a % by volume of the material in air. The LFL (LEL) is the Lowest Flammable Limit (Lowest Explosive Limit). The UFL (UEL) is the Upper Flammable Limit (Upper Explosive Limit). [NFPA 325 1-3.5].

**Flammable Liquids:** Flammable and Combustible Liquids Handling and Storage. defines Flammable Liquid as Class I Liquid any liquid that has a closed-cup flash point below 100°F (37.8°C) and a vapour pressure not exceeding 40 psi (2068.6 mm Hg) at 100°F (37.8°C). Flammable liquids also exhibit continuous vapour emission due to their associated low boiling points. Vapour produced may be heavier than air and will tend to travel and follow gullies and fill low lying areas, increasing the risk potential from the initial source. [NFPA 30 Sect 1-7.3]

Table 1: Flashpoints of Flammable and Combustible Liquids

Class I		Class II, IIIA, IIIB	
Flammable Liquids	Flash point °C	Combustible Liquids	Flash point °C
Gasoline	-43	Kerosene	+43
Methane	-187	Cooking oil	+200
Ethane	-135	Diesel oil	+300
Propane	-104	Gas oil	+350
Toluene	+4	Jet fuel	+100
Ethylene	-21	JP-6	+38

**Crude Oil:** is a commodity that is a cocktail of dissolved hydrocarbons, with each item having a different flash point.

## Fire Classes

Table 2: Fire classes

FIRE CLASSES			
EUROPE	HAZARD		USA
A	ORDINARY	COMBUSTIBLES	A
	E.G. WOOD, PAPER		
B	FLAMMABLE LIQUIDS		B
C	FLAMMABLE GASES		B
D	COMBUSTIBLE	METALS	D
	E.G. MAGNESIUM, TITANIUM		
E	LIVE ELECTRICAL EQUIPMENT		C

In Europe, fires are classified alphabetically into Class A, B, C, D, and E with each band in Table 2 itemising the particular “hazard”. These are defined in BS EN2 1992 (which, in the UK, replaced BS 4547:1972). In the USA, fires are classified according to NFPA 10, 1-3 as follows:

**Class A Fires** occurring in ordinary combustible materials, such as wood, cloth, paper rubber, and many plastics.

**Class B Fires** in flammable liquids, oils, greases, tars, oil-base paints, lacquers, and Flammable gases.

# Fire Engineering

## Fire Classes

**Class C Fires** that involve energised electrical equipment where the electrical non-conductivity of the extinguishing media is of importance. (When electrical equipment is de-energised, fire extinguishers for Class A or B fires may be used safely).

**Class D Fires** occurring in combustible metals, such as magnesium, titanium, zirconium, sodium, lithium, and potassium.

In the following sections we shall look closer at the separate fire classes under three related areas:

- Nature of the Hazard
- Recommended method of Detection
- Recommended method of Protection

## Class A fires

*Fig 7: Typical Class A fire*



**Hazard:** These fires involve ordinary combustibles such as wood, paper, rubber, and some plastics.

Class A fires may be deep seated and slow burning, with smouldering occurring within the material. This is characterised by low heat loss and slow consumption of fuel. Alternatively fast flaming combustion fires produce rapid vapour phase oxidation and the heat is transferred back to the fuel, in a continuous cycle. As shown in Fig.7 Class A fires, if not brought under control rapidly can develop in large conflagration such as a house fire.

**Detection of Class A fires:** During the development stages of a Class A fire, different detection technology appropriate to the product of combustion present during a particular stage. The different stages and appropriate detection methods are shown on Fig.8. The method of detection will vary according to how early in the fire that detection is required.

Fig 8: Class A fire curve

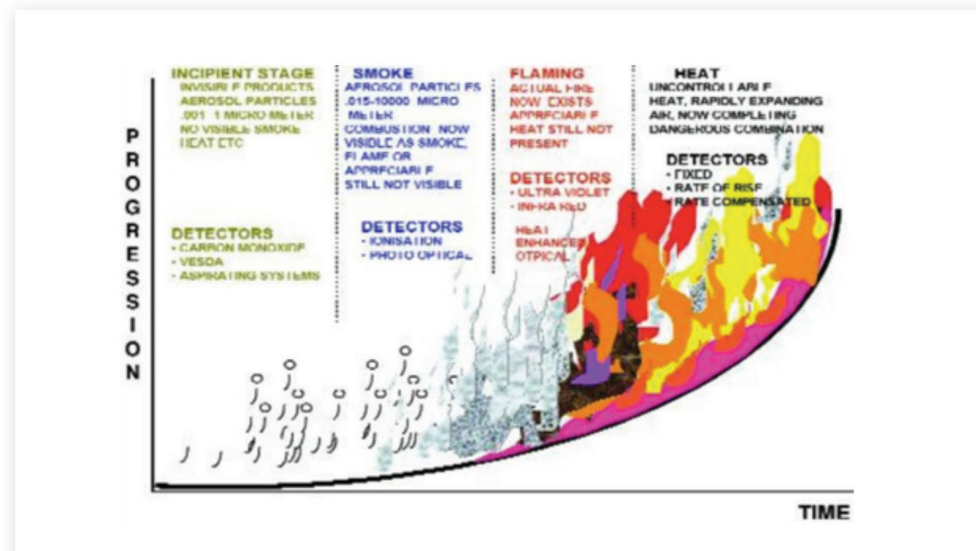

**Stage 1 - Incipient Stage:** The oxidation and combustion of materials at an incipient level will emit carbon monoxide (CO) and other gasses and vapours resulting from incomplete combustion. This is the first stage of a Class A fire. Materials heating up emit vapours, these vapours are invisible and can be detected by the following systems:

1. The human nose;
2. Carbon monoxide detectors, typically a solid state detector system which are now available in a format optimised for fire detection;
3. Smoke sampling system using special filtering systems and high intensity light to illuminate minute smoke particles such as Vesda (Very Early Smoke Detection Apparatus).

**Stage 2 - Smoking:** The combustion continues at a very slow pace, the vapour content increases to the point that the invisible vapours are now appearing as "smoke". The smoke which comprises an aerosol of particles can be detected by the following systems:

1. Photoelectric smoke detectors which detect the scatter of light caused when smoke particles cross a light beam in a sampling chamber within the detector;
2. Ion Chamber smoke detectors which are based on the reduction in the current flowing through an ionization chamber when combustion particles enter the detector chamber.

**Stage 3 - Flaming:** The increase in temperature and emission of vapours and gases now reach a critical stage. The vapours will ignite and combustion and flames will follow. The flame emits energy that has an UV and IR radiation content. The resultant flame can be detected by the following systems:

1. UV flame detectors;
2. IR flame detectors;
3. Combined UV/IR flame detectors;
4. Video motion detection systems using the visible light spectrum;
5. IR imaging flame detectors.

# Fire Engineering

## Class A fires

**Stage 4 - Heat:** By now the fire process is fully established, the products of combustion are fanned by the air turbulence, the fire is expanding rapidly and radiation, conduction and convection currents are radiating heat to surrounding areas. The heat from the fire can be detected by the following systems:

1. Heat fixed or rate of rise detectors;
2. Rate compensated heat detectors;
3. Linear heat detectors.

**Protection:** Class A fires require the heat absorbing (cooling) effects of water and water solutions or the coating effects of certain Dry Chemicals which retard combustion. Typical solutions include:

1. Sprinkler systems;
2. Deluge systems;
3. Hose reels;
4. Portable extinguishers.

## Class B fires

*Fig. 9: Typical Class B fire*



**Hazard:** Class B fires involve flammable liquids (see Fig.9). The combustion of these liquids involves rapid vapour-phase oxidation of the fuel. Subsequent involvement of more fuel, application of heat transfer and the feedback of air turbulence lead to rapid expansion of the fire cycle enveloping the vessel and culminating in a pool fire.

**Hazard:** Class B fires involve flammable liquids (see Fig.9). The combustion of these liquids involves rapid vapour-phase oxidation of the fuel. Subsequent involvement of more fuel, application of heat transfer and the feedback of air turbulence lead to rapid expansion of the fire cycle enveloping the vessel and culminating in a pool fire.

**Detection:** As indicated in Fig.10, flame detectors are typically used for Class B fires. The most suitable detection method is generally considered to be triple IR flame detectors. However, single and dual channel IR and UV/IR detectors are installed widely for these applications, as are point heat detectors. Linear heat detection systems also have applications particularly as a backup system where line-of-site devices are not practical and where metal or non-organic fires are the main risk. Triple IR flame detectors provide very low false alarm levels as well as good detection range.

*Fig.10: Detection of Class B fires*

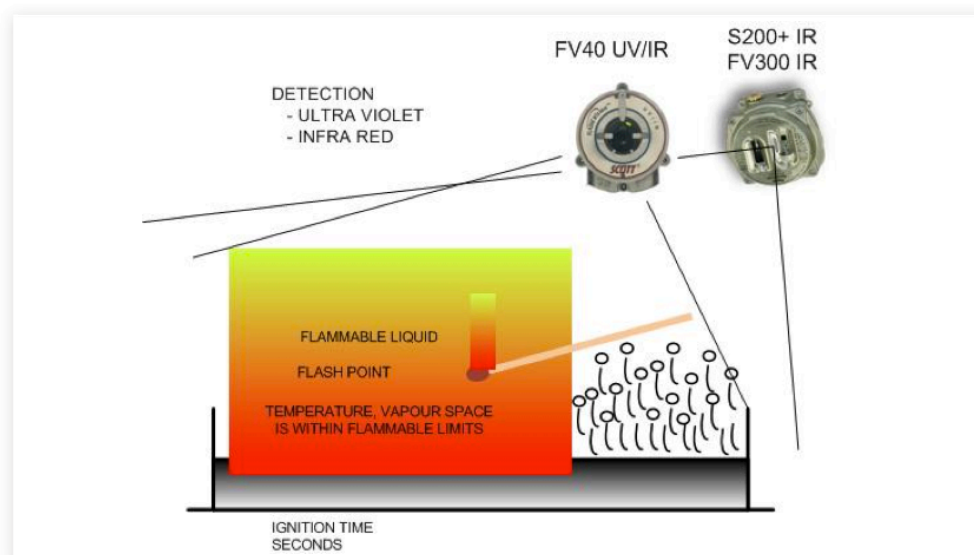

**Protection:** The suppression of Class B fires is most readily accomplished by excluding oxygen, inhibiting the release of combustible vapours, or interrupting the combustion chain reaction. Suppression materials are either water-soluble or water-insoluble.

Water-soluble materials require special alcohol-resistant foam agents that will not dissolve with the fuel. The use of foam is normally advocated for surface fires from foam monitors and foam tenders. Water spray systems may be provided for cooling of surfaces from radiated heat within the immediate hazard.

# Fire Engineering

## Class C fires (Europe)

*Fig.11: Typical Class C fire*



**Hazards:** Class C Fires as defined in Europe involve flammable/combustible gases. These gases are already at the “vapour phase”. An ignition source at this very vulnerable moment can cause an explosion or further escalation referred to as BLEVES (Boiling Liquid Expanding Vapour Explosion). Fig.11 illustrates a Class C fire inside a building.

**Detection:** The detection of Class C fires would typically be a combination of:

1. Gas detection (including early warning/plant shut down etc ....)
2. Flame detection as discussed in Section 4.6

**Protection:** Depending on the circumstances it may be prudent to do a “control burn”, using water spray systems until the source of fuel can be shut off. However, if the fire is in the position of spreading and escalation is assured, some practitioners would suggest the use of suppression providing that re-ignition can be avoided.



## Class D (combustible metals) fires

*Fig.12: Typical Class D fire in a furnace*



**Hazard:** Class D fires involve certain combustible metals such as magnesium, titanium, zirconium, sodium, potassium, etc. Fig.12 illustrates a Class D fire in an industrial furnace.

The combustion of metals involves a rapid oxidation that depends upon the chemical and physical properties of the metal involved. Generally, metals burn at higher temperatures, but with relatively low flame intensity. In certain configurations, metal fires can become deep-seated (i.e. magnesium dust) or if dispersed in the oxidiser, can be explosive. Titanium is used primarily in engine parts and for engine firewalls. Specially treated and processed titanium products are used in aircraft. These products tend to have a high degree of heat and fire resistance. Titanium metals are a friction spark hazard similar to steel and magnesium.

**Detection:** Class D metal fires are non-organic and produce IR and UV radiation. There is normally insignificant IR radiation emitted at  $4.3 \mu\text{m}$ , due to the lack of hot  $\text{CO}_2$  produced by metal fires. If aeroplanes and helicopters are involved, then hydrocarbon fuels could preside in a fuel fire. UV detectors will detect both metal and fuel fires, IR detectors would be used for fuel fire detection.

The other alternative is to use heat detection instead of or in addition to flame detection. Point detection is limited in its applications, mainly due to the delay in the heat reaching the detector location. However, linear heat detection has greater potential in these applications particularly as the new fibre optic based technologies provide enhanced performance in detection speed and location identification.

Video smoke detection and optical beam detection can also be useful in some applications.

# Fire Engineering

## Class D (combustible metals) fires

Video smoke detection and optical beam detection can also be useful in some applications.

**Protection:** Class D fires require special extinguishing agents that do not react with the burning metals. Foam agents are not recommended for Class D fires due to the reactivity of some combustible metals with water. They are however used to blanket fuel spills which may include class D fires.

The nature of the combustion process and hence the method of protection depends on the properties of the metal (i.e., zirconium burns explosively when dry, but when wetted with oil, burns more quietly). Titanium is difficult to extinguish and turbine engine fires involving titanium cannot normally be extinguished by external fire fighting techniques.

## Class E (Electrical fires)

*Fig.13: Typical Class E fire*



**Hazard:** European Class E or US Class C fires involve live energised electrical equipment Fig.13 illustrates a Class E fire in electrical equipment.

**Detection:** A combination of Photo optical smoke detection and ionisation smoke detection is the traditional method of approaching these risks. Difficulty in extinguishing has led to more emphasis on early detection using aspirating systems and linear heat detection systems. Flame detection does have application particularly with transformer stations.

**Protection:** Operator safety requires the use of electrically non-conductive extinguishing agents.

Foam agents are not recommended for Class E fires due to the conductivity of the agent resulting from the high water content.

When electrical equipment is de-energised, foam agents may be used in certain circumstances.

# Protection of Electronic Equipment

The nature of the hazards which flame detectors are being used for detecting (typically Class B fires) means that the flame detectors must frequently be installed themselves in hazardous areas. This section looks at the way in which hazardous areas are classified and the implications of this on the specification of the electronic detection equipment (see Fig.14).

*Fig.14: Area (zone) Classification*

## AREA ZONE CLASIFICATION

This classification relates only to explosion risk due to flammable gases and vapours. It does not relate to dust explosion risks.

**ZONE0:** A Zone in which an explosive gas/air mixture is continually present, or present for long periods of time.

**ZONE1:** A Zone in which an explosive gas/air mixture is likely to occur under normal opening conditions.

**ZONE2:** A Zone in which an explosive gas/air mixture is unlikely to occur under normal opening conditions and, if it does, it will exist only.

## Hazardous Area (zone) Classifications

Typically those industrial processes utilising oil and its derivatives, natural gases, synthetic process gases, organic (flour, coal, grain etc) and metal dusts, can give rise to an explosive atmosphere. Various techniques have been developed over the years, which enable the use of electrical equipment in such areas.

National and international standards have been generated so that electrical systems design practice in such areas are controlled and monitored.

The Classifications of hazardous areas are indicators of the probability of a hazardous atmosphere being present due to the presence of flammable vapours and gases. Some of the main standards bodies having jurisdiction are:

- Institute of Petroleum (IP-15).
- American Petroleum Institute (API RP500-1991).
- International Electrotechnical Committee (IEC79-10).
- National Electrical Code (NFPA 70- Article 500) etc.
- British Standards BS 5345 Pt 2.

## Protection of Electronic Equipment

### Hazardous Area (zone) Classifications

Key differences between European (IEC) and North American practices:

1. IEC has two categories (Ex ib and Ex ia), which ensures protection being maintained with either one or two faults respectively. Ex ia rated equipment may be used in zone 0, 1 and 2. Ex ib rated equipment may only be used in zone 1 and 2 hazardous areas. USA and Canada use one category only with up to two faults.
2. USA and Canada area classification is defined as Division 1 and Division 2. Division 1 includes hazardous concentrations of flammable gases or vapours - or combustible dusts in suspension - continuously, intermittently or periodically present under normal operating conditions. Division 2 includes volatile flammable liquids or flammable gases, but normally confined within closed containers or systems from which they can escape only under abnormal operating or fault conditions. Division 2 also includes combustible dusts not normally in suspension nor likely to be thrown into suspension.

*Table 3: Area (zone) Classification Europe & North America*

HAZARDOUS AREA CLASSIFICATION			
CONTINUOUS HAZARDS		INTERMITTENT HAZARDS	HAZARD UNDER ABNORMAL CONDITIONS
IEC/EUROPE	ZONE 0	ZONE 1	ZONE 2
USA	DIVISION 1		DIVISION 2

### Non-Hazardous Areas

Areas that are not classified as hazardous, such as control rooms, are referred to as “non-hazardous areas”. Due to the siting of control rooms, circumstances may prevail that the non-hazardous area may be in danger of being enveloped in a “flammable atmosphere”, posing an emergency situation for operations, equipment and staff.

It is good practice for equipment to meet the safety requirements and functionality of an explosive atmosphere in view of the hypothetical becoming a reality. Control areas should operate in a positive pressure environment, creating the conditions that will maintain a non-hazardous atmosphere.

## Apparatus Gas Grouping

Fig.15: IEC Apparatus Gas Grouping

REPRESENTATIVE GAS	IEC GROUP	SPARK IGNITION ENERGY $\mu$ JOULES	INCINDIVITY
METHANE (MINING)	I		
PROPANE	IIA	180	LEAST INCINDIVE
ETHYLENE	IIB	60	
HYDROGEN	IIC	20	
ACETYLENE	IIC	20	MOST INCINDIVE



IEC and USA/Canada both classify the gases, vapours and dusts according to the spark energy required to ignite the mixture with air. IEC groups apparatus according to the gases that it may be used with and this is shown in Fig.15. USA/Canada has separate classes for gases, dusts and fibres as shown below:

- Class I, Group A: Acetylene
- Class I, Group B: Hydrogen
- Class I, Group C: Ethylene
- Class I, Group D: Propane
- Class II, Group E: Metal dust
- Class II, Group F: Carbon dust
- Class II, Group G: Flour, starch, and grain
- Class III, Group G: Fibres and flyings

# Protection of Electronic Equipment

## Temperature Classification

Fig.16: Temperature Classification

TEMPERATURE CLASSIFICATION	
Temperature Classification	Maximum surface Temperature of apparatus
T1	450 °C
T2	300 °C
T3	200 °C
T4	135 °C
T5	100 °C
T6	85 °C

Flammable Gas-air mixtures can ignite by contacting hot surfaces. The maximum equipment surface temperature must be lower than the minimum ignition temperature. Fig.16 lists the maximum surface temperature for each temperature classification. Electrical equipment operating in hazardous atmospheres must be classified according to its maximum surface temperature for the gases which are present.

The larger the temperature classification numbers (i.e.T6) on equipment is, the greater the number of flammable gases that can be accommodated safely. Details of the classification and the ignition temperatures of commonly used gases and vapours are contained within the following standards:

IEC 79-20, EN50014, BS 5345 Pt 1, VDE 0165, NFPA 325M, NFPA 497M, CSA C22.1

Table 4: Surface temperature classification in Europe and North America

Max temperature (°C)	European classification	Max temperature (°F)	USA/Canadian classification
450 °C	T1	842 °F	T1
300 °C	T2	572 °F	T2
280 °C	-	536 °F	T2A
260 °C	-	500 °F	T2B
230 °C	-	446 °F	T2C
215 °C	-	419 °F	T2D
200 °C	T3	392 °F	T3
180 °C	-	356 °F	T3A
165 °C	-	329 °F	T3B
160 °C	-	320 °F	T3C
135 °C	T4	275 °F	T4
120 °C	-	248 °F	T4A
100 °C	T5	212 °F	T5
85 °C	T6	185 °F	T6

Table 4 lists some surface temperature classifications in Europe and North America. Each gas is associated with a temperature class based on its ignition temperature. It is important to note that there is no correlation, for a certain mixture, between ignition energy and ignition temperature.

For example, hydrogen has minimum ignition energy of 20  $\mu$ J and an ignition temperature of 560 °C (1040 °F) while acetaldehyde has ignition energy of more than 180  $\mu$ J yet an ignition temperature of only 140 °C (284 °F).

Maximum surface temperature, calculated or measured in the worst condition, is not to be confused with the maximum working temperature of the apparatus.

# Protection of Electronic Equipment

## Types of Protection

Table 5: Types of Protection in Hazardous Areas

ZONE	TYPE OF PROTECTION
0	1. Intrinsically Safe EEX ia
1	2. Special protection EEX s to SFA 3009
	1. Any type of protection suitable for Zone 0
	2. Flameproof EEX d
	3. Intrinsically Safe EEX ib
	4. Pressurized EEX p
	5. Increased safety EEX e
	6. Special protection EEX s to SFA 3009 (where different from EEX s in Zone 0)
2	1. Any type of protection suitable for Zone 0 and Zone 1
	2. EEX n
	3. Oil immersed EEX o
	4. Quartz filled EEX q

Methods of protection of electrical equipment used within the European Community are termed “Explosion Protection”. The symbol “Ex” i.e.: “explosionsgeschützten” is derived from German contribution to work carried out on explosion protection.

Table 5 illustrates the different techniques available. Essentially Protection is carried out by three systems:

**PREVENTION** which is the limiting of energy to levels that will not allow an explosive gas air mixture to ignite (Ex ia Intrinsic Safety).

**CONTAINMENT** allows the explosion to occur but does not allow propagation in to the surrounding area (EEx d Flameproof).

**SEPARATION** is the segregation and isolation of hot surfaces from explosive atmospheres (pressurisation/encapsulation).

Relevant standards include:

- CENELEC Standards EN 50 014 embodies all protection techniques.
- CENELEC EN 50 020 Apparatus Standard EN 50 039 System Standard
- BS 5345 Pt 4 is the UK Code of Practice (current 1989) Intrinsic Safety
- BS 5501 PT 7 & 9 British Standard Intrinsic Safety



## Intrinsically Safe Barriers

One method of protection is defined as INTRINSICALLY SAFE. This method uses Safety Barriers in the electrical circuit feeding the Hazardous Area in order to limit the voltage excursion and the current. The limit of voltage and current will prevent a fault within the Intrinsically Safe circuit exceeding the ignition conditions.

These safety barriers are Intrinsically Safe electronic devices, interfacing the Non-Hazardous Area with the Hazardous Area.

Two types of safety barrier are in common use: 1) Zener (diodes) barriers and 2) Galvanic isolators:

### Zener diode barriers

Fig. 17: Typical Zener barrier arrangement

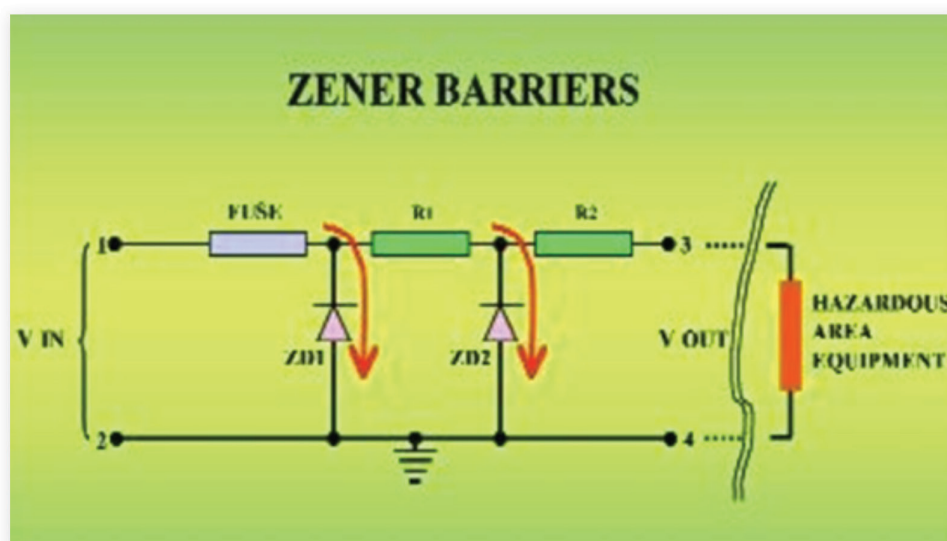

Zener barriers provide the simplest method of voltage regulation and current limitation. Fig. 17 illustrates a typical Zener barrier configuration. During “normal” operation the diodes conduct to earth. During “abnormal” conditions, if the operating voltage is exceeded, the diode operates in the Zener (avalanche) mode; the diode characteristic knee is exceeded, permitting the device to conduct heavily to earth, thus diverting excess current away from the hazardous areas. The connection to earth at the barrier needs to be a high integrity earth - less than  $0.1 \Omega$  with a 4 mm cross sectional area cable core. In some instances the intrinsically safe earth has to be kept separate from other earths in the system. This can be costly, as remote barrier locations may have to connect together centrally. This separate (central) intrinsically safe earth is then connected to a suitable system earth. These potential earth problems can be overcome by the use of galvanic isolators.

# Protection of Electronic Equipment

## Galvanic isolators

Fig.18: Galvanic Isolator

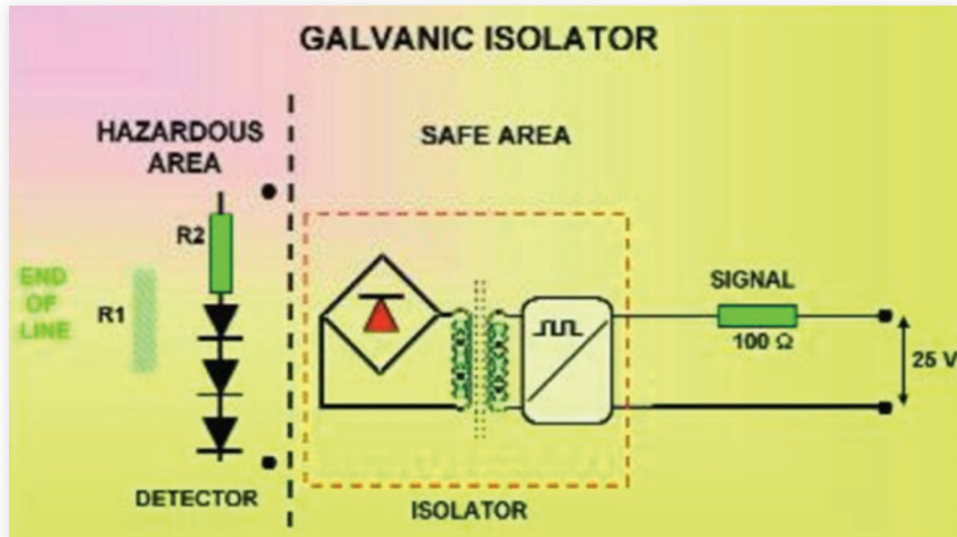

Galvanic Isolators connect the Safe Area to the Hazardous Area using one of the following methods:

- a) Transformer coupling, where the connection between the two windings uses inductive transformer action.
- b) Opto-coupling uses light transmission via photo-transistors to transfer signals between the two areas thus eliminating direct physical connections.
- c) Mechanical Relays, provide the same function, the movable contacts are actuated by induction/ magnetism.

Fig.18 illustrates a typical galvanic isolator configuration.

### Advantages of galvanic Isolation:

1. In a galvanic isolator circuits are essentially “floating free of earth”, thus an earth fault in the Hazardous Area will not be transmitted to the Safe Area and will not affect system operation. Costly high integrity earthing is not required.
2. The safe area side of an isolator presents a simpler solution for signal conditioning and interfacing.

## Intrinsic Safety

To preclude the risk of an explosion, equipment in the Hazardous Area must not be capable of causing ignition under normal operating, or specific fault condition. Limiting the energy which can be stored in, and released by, electronic circuitry and cables in the Hazardous Area is achieved by using Intrinsically Safe (IS) equipment and by placing restrictions on the cable parameters. If the electrical energy in a circuit is less than the value required to ignite a potentially explosive mixture then the circuit is said to be INTRINSICALLY SAFE. Normal power from a barrier is restricted to approximately 1 Watt. IS systems are the most widely used in zone 0 hazardous areas.

Certification in the past was applied to IS systems as a whole. The certificate would include all equipment in the system, including the safe area equipment. This approach was viewed as being very restrictive and now it is generally accepted that there can be some degree of interchange-ability between equipment and barrier manufacturers. The equipment must be electrically compatible and one should always consult the relevant manufacturer for approval

## Flameproof

*Fig.10: Detection of Class B fires*



Fig.19 gives examples of flameproof (explosion proof) EExd enclosure for a) a terminal box and b) a torch. The explosion protection for this type of hazardous area equipment is built around the following philosophy:

1. it relies on mechanical construction.
2. it is based around the containment of an explosion, without transmitting energy to the external atmosphere.
3. a maximum gap is specified between the lid and the body of the enclosure which helps to cool hot gases.
4. EEx d enclosures are not necessarily watertight.

# Protection of Electronic Equipment

## Flameproof

5. EEx d equipment must be isolated before maintenance work commences; a Permit to work or “hot” work permit is required before maintenance work can be done.
6. all securing bolts must be a) in place and b) tight.
7. all unused cable entries must be properly sealed.
8. cable glands must be EEx d.
9. EEx d protection is suitable only for Zones 1 & 2.
10. EEx d is suitable for all gas groups subject to the conditions of Temperature Classification being met.
11. CENELEC standard EN 50018 applies in Europe.

## Equipment Marking

Electrical equipment used in Hazardous Areas must be submitted for approval to the body having jurisdiction. The equipment is inspected, configured, operated and tested under worst case conditions to meet the requirements of Standards Organisations. In addition the manufacturing quality and control systems are inspected.

*Fig.20: Equipment Marking*

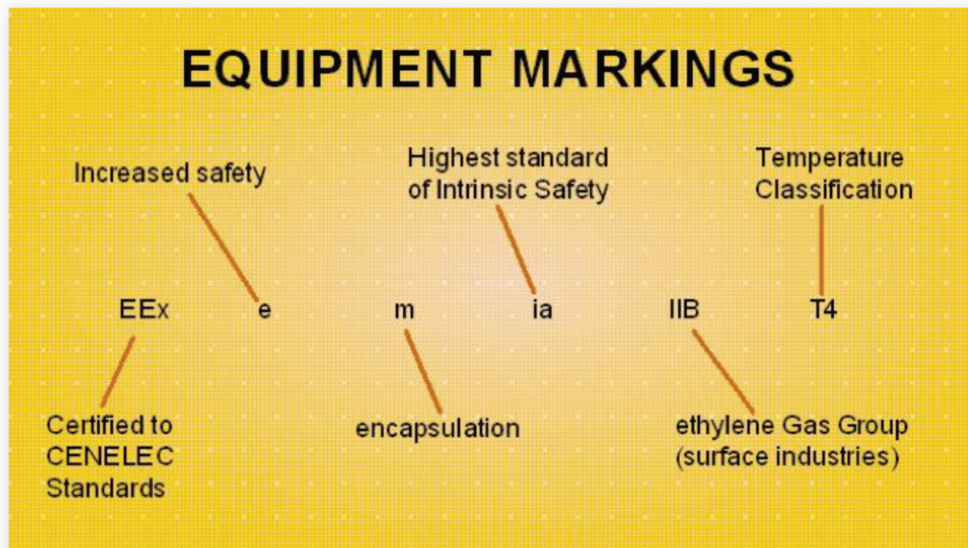

On meeting the criteria, the equipment is fitted with an “Approved Label” which qualifies its operation parameters using the markings shown in Fig.20.

# Typical Flame Detector Applications

This section provides some guidelines for applying flame detectors to specific applications. This section is by no means fully comprehensive but represents field experience collected from within Tyco at the time of going to press. As other application data is ratified this will be added to future issues of this section. Meanwhile any readers who have application knowledge that can be contributed would be welcomed.

Whilst the applications are very specific, the concepts used in applying detectors to these applications can be adapted to many novel applications.

## Dike / Storage Protection

*Fig.21: Dike Storage area (25-meter diameter tanks).*

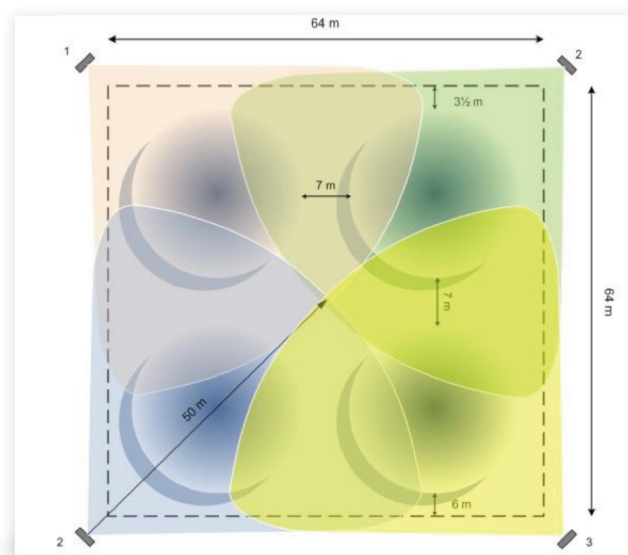

*Note: The example in Fig.21 illustrate four FV300 IR array flame sited to provide complete and comprehensive coverage of four 25 m diameter fuel storage tanks in a bund area of one acre. The long range and wide cone of vision of the FV300 is a factor in minimising the number of detectors used while maintaining effective coverage. It would be necessary to fit additional detectors where voting between two or more detectors is required.*

### General

Outdoor Storage Tanks are usually constructed in accordance with the requirements of NFPA 30, Flammable and Combustible Liquids Code.

A liquid-spill fire in this area has the potential for enormous growth. The sheer volume of flammable material available presents enormous problems if the contents of the storage vessel are released. Whether the type of fuel is liquid or gas needs consideration. Liquid storage or gas storage tanks require detection at the "fill areas" and liquid storage tanks with electric mixing motors need the motor to be monitored.

# Typical Flame Detector Applications

## Dike / Storage Protection

### Hazards

Product stored may include Flammable and Combustible liquids with varying flash points such as:

- i. Aircraft fuels, diesels, Jet fuels, JP4.
- ii. Gasoline's, alcohol's, solvents and other hydrocarbon based products.

Examples of fire and spill incidents could include tank overfills, seal fires, floating roof with a sunk internal roof, tank or piping failures, full surface fire, etc.

Example site details (Fig.21):

1. Tank farm bund size = 64 m x 64 m
2. No. of storage vessels = 4
3. Vessel diameter = 25 m
4. Vessel height = 6 m

### Detection

The tank size (as indicated in Fig 21) allows detectors to be sited on the bund perimeter, providing good coverage for bund and tank protection. In this instance, detectors should be sited at a height which permits detection of fires on a tank roof. For floating roof tanks, detectors should also ideally be mounted on the periphery of the tank to detect rim seal fires). The use of Tyco IR Flame Detectors, such as the FV300 will permit coverage of tank surfaces as well as spillage areas. The following principles apply:

1. Detectors are sited in accordance with the polar plot provided in the detector user manual.
2. The detector should be sited so that its cone of vision does not scan the horizon (Fig.22).
3. Amount of detectors used on a given installation will normally depend upon:
  - i) redundancy,
  - ii) voting arrangements.

Generally the risk is covered by a series of detectors containing the hazard within the 90° cone of vision with a degree of overlap. On a fire condition the detectors are voted to give a "2 out of x" depending on the client's requirements and good fire engineering practice.

Fig.22: FV 300 cone of vision

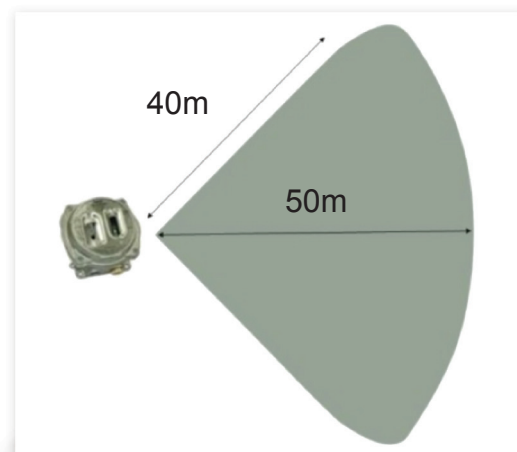

### Extinguishment

- Fixed water spray systems
- Monitors / foam cannon
- Foam

## Floating Roof Tank

### General principles

Outdoor Storage Tanks are generally constructed in accordance with the requirements of NFPA 30, Flammable and Combustible Liquids Code.

Within the scope of this Code, open-top floating roof tanks are defined as vertical cylindrical tanks without fixed roofs that have double-deck or pontoon-type floating roofs. The seal can be a mechanical shoe seal or tube seal. The tube seal can be equipped with a metal weather shield. Secondary seals of combustible or non-combustible materials can also be installed.

In this section, two types of protection are considered, one with flame detectors placed on the rim of the tank and the other with flame detectors suspended above the centre of the tank.

### Hazards

Product stored may include Flammable or Combustible liquids with varying flash points:

1. Aircraft fuels, diesels, Jet fuels, JP4
2. Gasoline's, alcohol's, solvents and other hydrocarbon based products

Examples of fire and spill incidents could include tank overfills, seal fires, floating roof with a sunk internal roof, tank or piping failures, full surface fire, etc  
Extinguishment:

- Fixed water spray systems
- Monitors / foam cannon
- Foam

## Protection of floating roof tanks with rim detectors

*Fig.23: 100-meter floating roof tank with FV300 IR image-based protection*

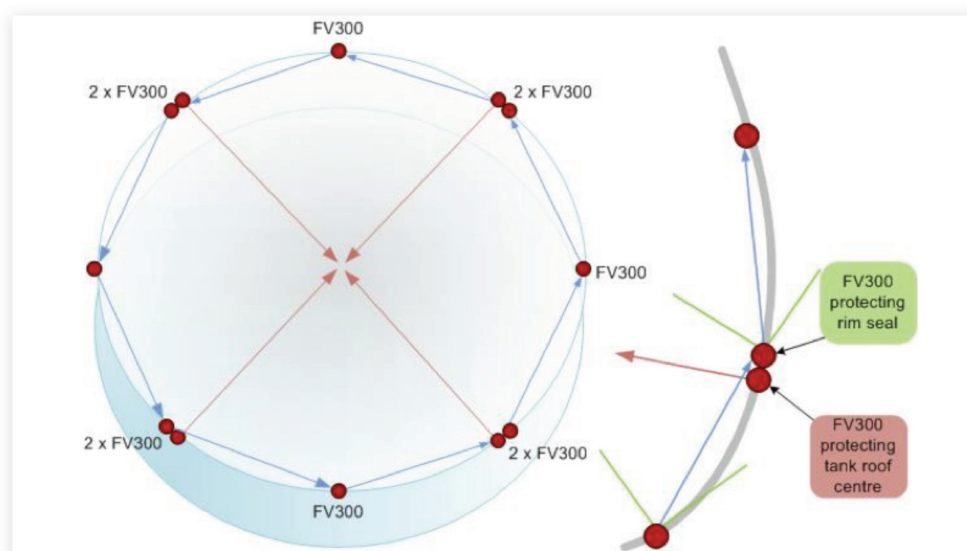

# Typical Flame Detector Applications

## Protection of floating roof tanks with rim detectors

Example installation details (Fig.23):

1. Tank diameter = 100 m
2. Tank height = 27 m
3. Tank circumference = 314 m
4. Number of detectors on circumference:
  - i) 8 x FV300 located every 45°, providing rim seal protection
  - ii) 4 x FV300 located 90° apart, providing tank roof protection

### Detection

Fig.24: Diagram showing rim seal coverage with FV300 Array IR Flame detectors

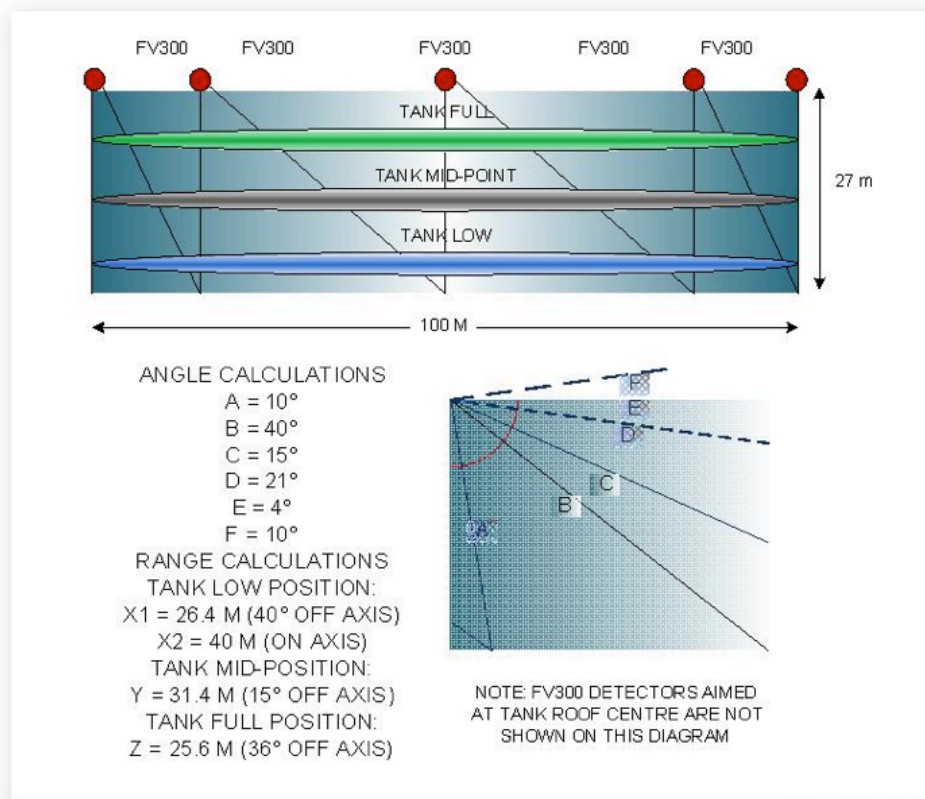

The main issue to bear in mind with the design of fire detection for floating roof tanks is that the roof itself may move in accordance with the quantity of fluid stored. The fire detection system design should account for this movement and should not be degraded within the limits of roof movement.

It is quite typical for detectors to be sited on the outer wall of the tank. In some instances detectors are mounted on the floating roof, but this technique is relatively uncommon and is not discussed in this example.



## Protection of floating roof tanks with rim detectors

Storage tanks are built in differing sizes and are used to store a variety of materials. There is no single fixed method which enables repeatable siting of detectors to protect storage tanks of varying sizes and applications. The example shown in Fig.23 and Fig.25 depicts a tank with a diameter far in excess of the maximum detector range. The degree of protection in this design is minimal, and does not include for additional detectors that would be required for voting or redundancy. The design can be achieved using the FV300 IR Array flame detector.

Fig.24 shows typical calculations which should be included in the system design. The rim seal detectors in this design are sited so that the detector range at  $45^\circ$  from the detector axis does not exceed either:-

1. the distance between two detectors (Z) ,
2. the distance from the detector to the lowest possible tank level (X1).

The distance X2 is within the maximum effective range of the detector, and thus the rim seal is adequately protected. Also note that the angle A ( $45^\circ$  off axis and the tank perpendicular) is shown as  $10^\circ$ . This offset permits the detection distance Z to be increased, and thus ensuring maximum detection distances are within the ranges of polar plots provided in the user manual.

The other four detectors provide tank roof protection. Two of these detectors are sited to provide coverage at the tank full position. The other two detectors protect the roof at the tank low level.

*Fig.25: General arrangement for FV300 detectors on 100 m floating*

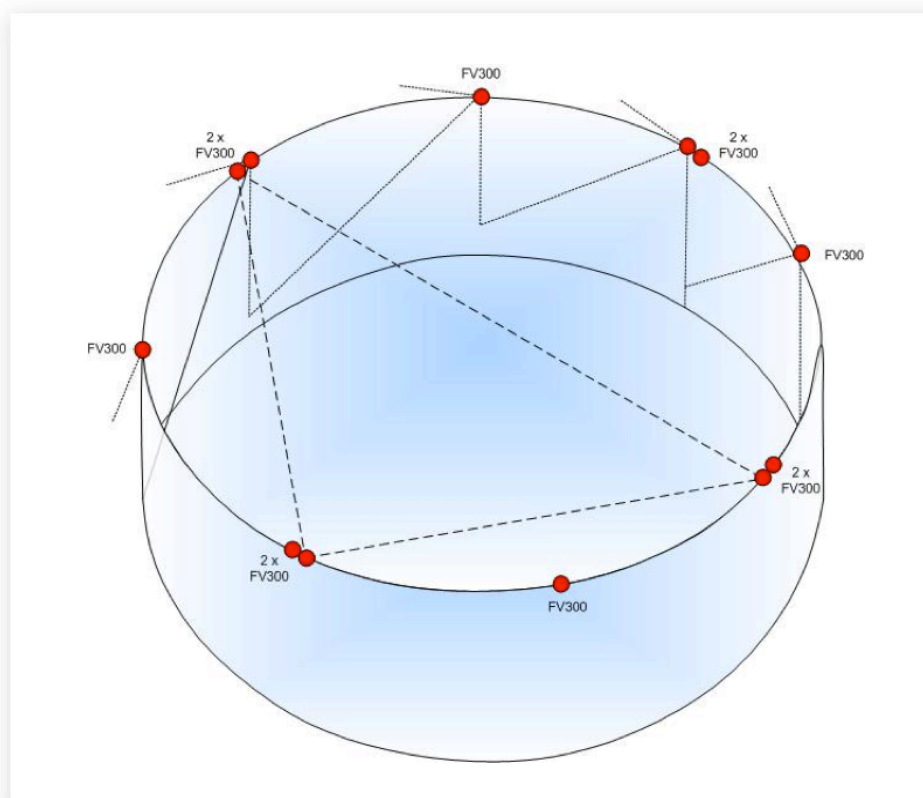

# Typical Flame Detector Applications

## Floating roof tank protection using overhead detectors

Fig.26: 50 m floating roof tank with IR flame detectors centrally positioned above the tank

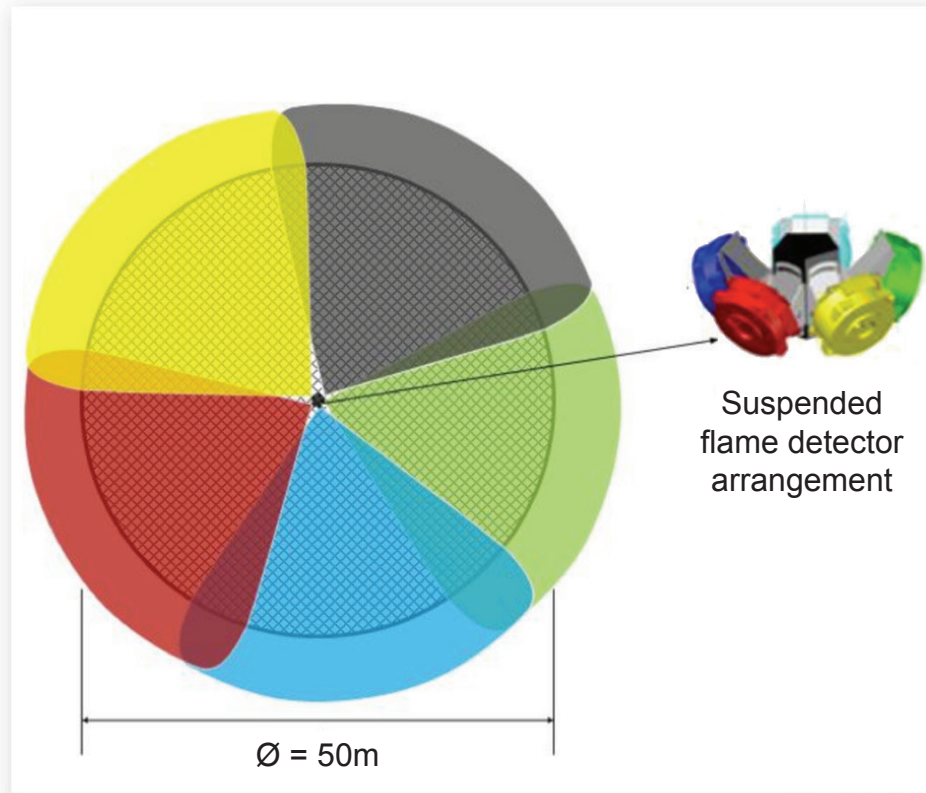

Example installation details (Fig.26, Fig.27):

1. Tank diameter = 50 m
2. Tank height = 30 m
3. Tank circumference = 157 m
4. Number of detectors: 5 x detectors suspended on a gantry above the centre of the tank
5. Height of the detectors above the top surface of the tank = 7 m.

### Detection

An alternative arrangement for the protection of floating roof tanks is to position the detectors above the centre of the tank. It is important in designing such an installation that the number of detectors used, their height above the top surface of the tank and the angle at which they are orientated is determined so as to ensure full coverage of the rim circumference when the tank is full as well as coverage of the furthest points when the tank is empty.

Fig.26 shows an overhead view of a typical arrangement of 5 x FV300 IR image based detectors mounted on a hexagonal suspension rod. Fig.27 shows how the protection is achieved in the vertical plane to protect a 30 m deep tank. Fig.27 also shows how the detector arrangement will be able to detect fires on the rim of the tank and when the tank is partially full or nearly empty.

## Floating roof tank protection using overhead detectors

Fig.27: Example of 50 m diameter by 30 m deep tank protected with overhead detectors

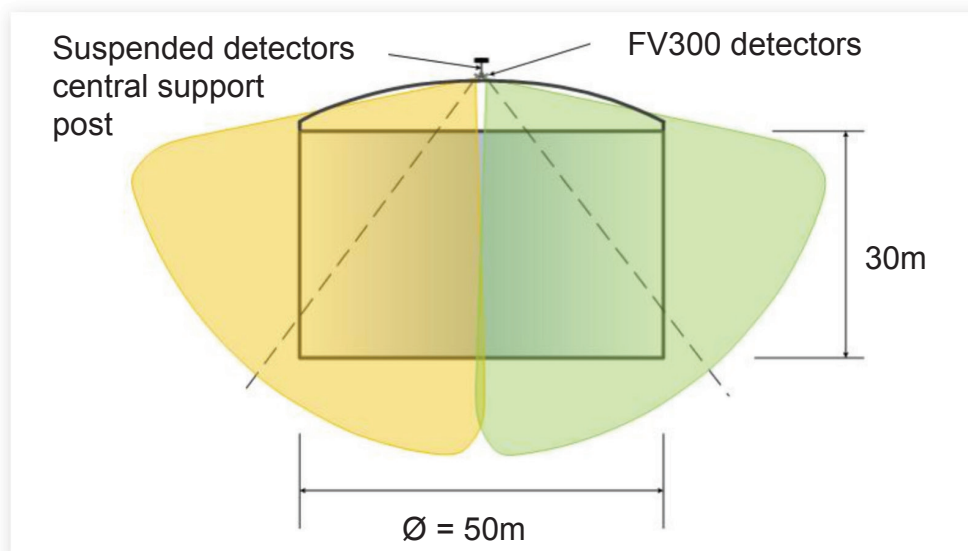

In the design of this type of detection system, the diameter and height of the floating roof tank together with the detection coverage (cone of vision) of the detectors must be considered when calculating the number of detectors used and their position. The need for overlapping the cone of vision of each detector to achieve full coverage of the risk must also be taken into account. It would be necessary to fit additional detectors where voting between two or more detectors is required.

# Typical Flame Detector Applications

## Fuel Transport Load Facility

Fig.28: Transport loading facility

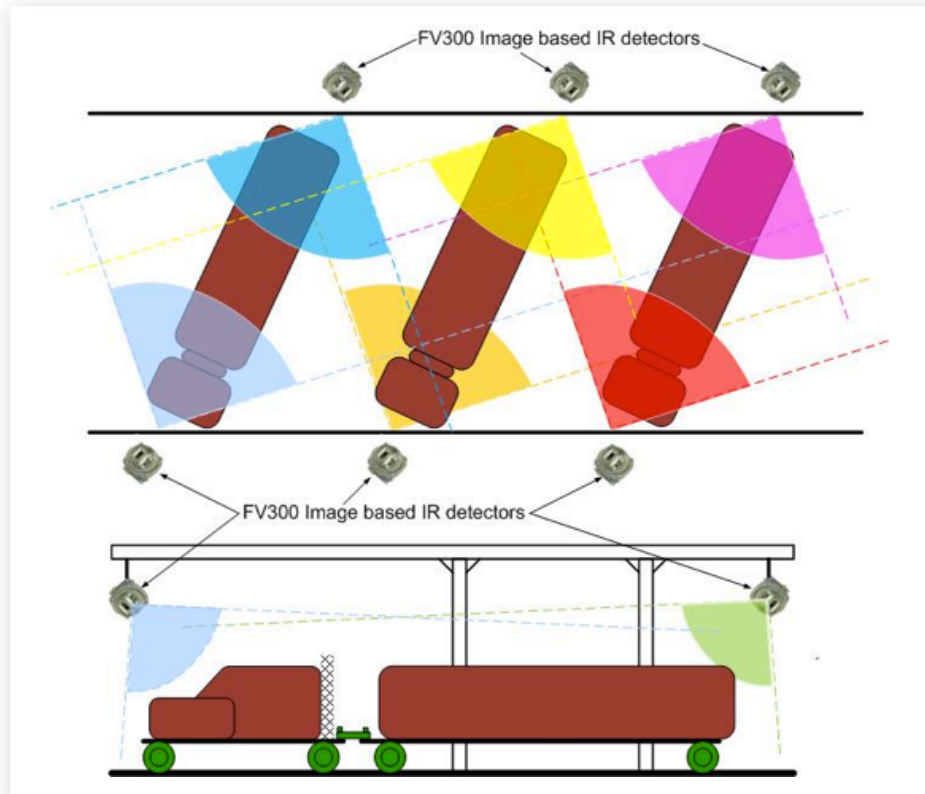

### General

Fuel Transfer Trucks are generally “bottom loading”. Detectors within the loading facility are installed on both sides of the vehicle front and rear to allow immediate detection of any spill fire that ensues. Redundant detection coverage ensures early warning and activation of the deluge system, which is an important ingredient in extinguishing any fire before it has time to spread and develop.

### Hazards

Hydrocarbon Product Fires including Methane, Crude oil, Gasoline and Propane. Typical ignition sources are Static electricity or faulty electrical equipment. The rupture or disengagement of hose-lines can cause fuel spillage, which contributes to the overall fire hazard.

### Site details

The load facility shown in Fig.28 indicates that adequate coverage can be achieved using strategically placed detectors with a wide cone of vision such as the Tyco FV300 Image-based IR flame. Each truck shown in Fig.28 and their immediate surrounding area is covered by two detectors to enable redundant detection for the safe activation of protection measures. The area to protect includes the canopy, pumps, meters, vehicles and miscellaneous equipment. In order to protect the area against spillage it is desirable to site detectors to cover the total curbed area around the loading rack or the complete truck length.

## Fuel Transport Load Facility

### Detection

The main factors to consider for any system design are, as follows:

1. Ensure the detectors cone of vision covers the risk.
2. Design the system with redundant detector coverage.
3. Detectors are voted "2 out of x" thus minimising false alarms and providing maximum redundancy. Redundant coverage ensures fast response, activating deluge water spray system.
4. The speed of response of the overall protection system should meet with the client's approval.

### Extinguishment:

- Deluge system initiated by "2 out of x" detector arrangement
- Dry Chemical
- Foam

## Diesel Engine

*Fig.29: Diesel Engine room*

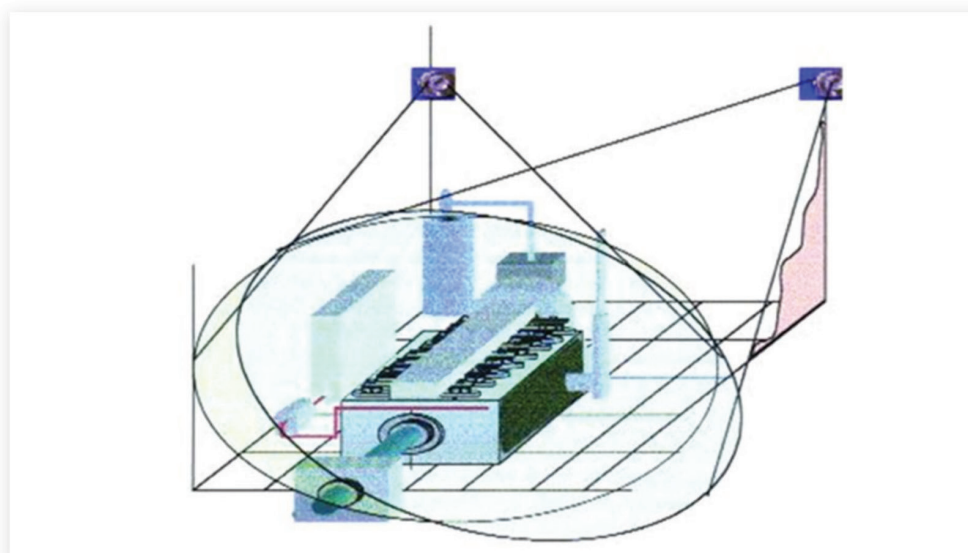

### General

Diesel engines are used in many industries and constitute a fire hazard regardless of their industry of application. Fig.29 illustrates a diesel room application.

# Typical Flame Detector Applications

## Diesel Engine

### Hazards

Engine surface temperatures can exceed the flash point of diesel and lubrication oil. The normal high-risk areas are the exhaust manifold, turbochargers, fuel lines, bearings, brakes and gears. The environment can be one where oil mist is continually present in the atmosphere. Fractures in fuel pipes, high-pressure oil leaks, failures in pumps, bearings, can lead to oil spillage and flammable vapours contacting hot exhaust manifold piping.

Associated electrical equipment (e.g. generators, cabling, motors, pumps, switches, and transformers) also presents a potential source of ignition. External combustion material can increase the hazard. These materials could be in the form of grease, oil, cleaning solvents, rags, electrical insulation, hose-lines etc. Cutting and welding work may take place in such environments.

### Site details

Diesel engines come in many sizes and layouts. It is important to know the location of the high-risk areas of the engine so that good coverage can be achieved. Site drawings should contain sufficient detail, to permit good system design practice.

### Detection

Sensors should be chosen to provide early detection, whilst maintaining maximum immunity to false alarm sources. False alarms from black body radiation can be significantly reduced by the application of multi-channel, infrared flame detectors. Fire detection devices can be used to provide early warning of fires and provide outputs to shut down equipment, operate other systems such as door closers and exhaust fans and actuate a fire suppression system.

Detectors are placed so that cone of vision captures the "risk". Redundant coverage ensures reliable response, when activating the extinguishing system.

### Extinguishment

- CO2/ Gaseous suppression systems
- Deluge system
- Dry Chemical/ Foam

## Aircraft and Hangars

Fig.30: Aircraft hangar detector layout

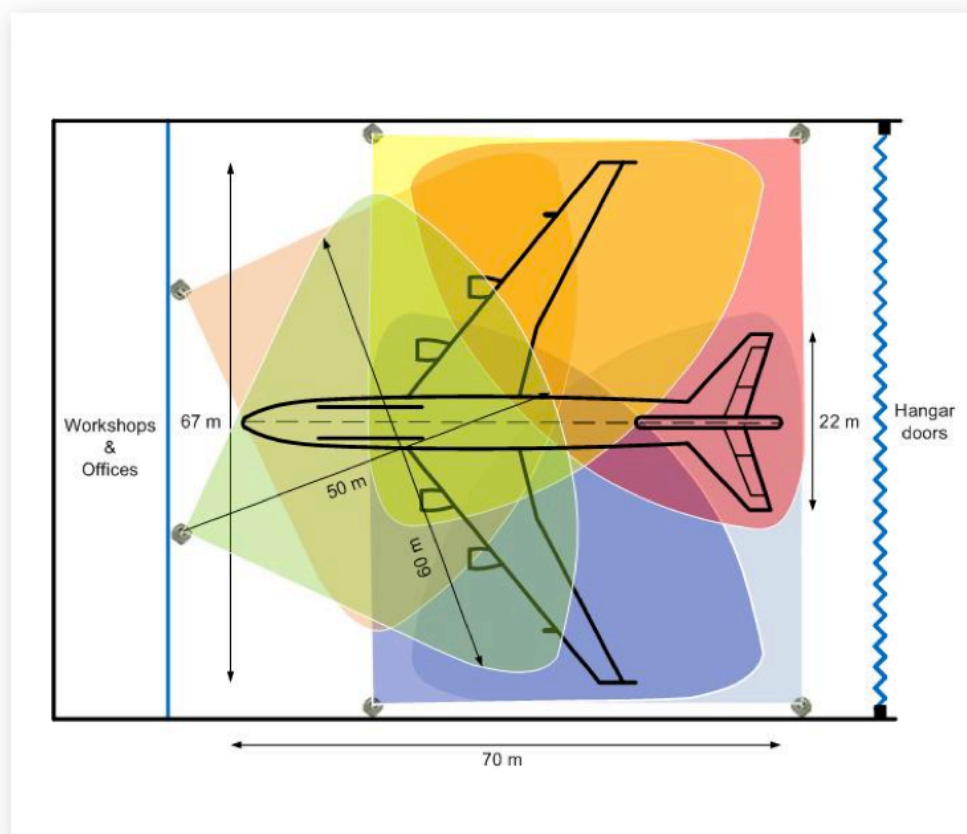

### General

An aircraft hangar is simply a large structure built to provide weather protection and shop space during aircraft maintenance and storage. However, special fire protection problems associated with a hangar are due to the nature of its occupancy. Since it is impractical and economically unsound to remove all fuel from an aircraft prior to moving it to a hangar, the potential always exists for having large quantities of flammable liquids, mainly aviation fuel, inside the hangar. Quite often the aircraft contained within the hangar, are particularly large, and are several times more valuable than the hangar, necessitating some measure of protection for the aircraft as well as the hangar. (Extract from NFPA Industrial Fire Hazards Handbook). Fig.30 illustrates a typical aircraft hangar application.

Aircraft and hangars are generally protected in line with NFPA409 which forms the basic reference and which recommends the use of heat detectors as the primary detection for initiation of extinguishing systems.

However FM Datasheets 7-93N, Exhibit, highlights the need for secondary systems to provide rapid detection and suppression of under-wing and centre wing fuselage areas.

# Typical Flame Detector Applications

## Aircraft and Hangars

### Exhibit 1

Tests on aircraft fuselages have indicated that an aircraft skin will fail after 45 seconds of spill fire exposure. If doors or compartments are open, fire may spread into the interior in an appreciably shorter time. Although it is expected that foam discharge from an overhead foam-water sprinkler system would eventually flow beneath the aircraft, the time required would be well in excess of 45 seconds. The most important structural part of an aircraft is the fuselage area between the wings (the wing centre section). Distortion or failure of the wing support is irreparable.

Other portions of the fuselage can be repaired or replaced. Generally, aircraft fuel tanks are of the “wet wing” type. If they contain fuel, the fuel will provide some cooling. On the other hand, if one or more tanks are empty, a fuel fire exposure could rapidly destroy the wing. Thus, regardless of the type of primary protection system provided, foam discharge from supplementary systems should be directed to those areas beneath the wings and wing centre section. In addition, in hangars protected by water deluge systems, foam should also be directed to those areas beneath the fuselage where fuel can flow. (Source: FM Data Sheet 7-93N).

Whilst it is recommended that supplementary systems using flame detection are used for under-wing protection, Exhibit 2 is a draft proposal for a modification to NFPA 409 allowing the use of flame detectors for primary protection.

### Exhibit 2 - Proposal for revision to NFPA409:

**NFPA 409 3-2.11.1:** Detectors for actuating the primary systems shall be rate-of-rise, fixed temperature or rate compensated thermal detectors, or for hangars where the response will be too slow, flame detectors. Flame detectors would need to be installed in a cross-zone configuration.

#### *Statement of problem and substantiation for proposal:*

Many modern hangars built and used in the tropical parts of Asia today involve high ceilings, built on large free-spanning space-frame structures, with open sides. There are no doors available to close the hangar. Such high ceilings and open sides prevent sufficient heat build up from a fire to activate the thermal detection system.

The tropical conditions often render the thermal systems inoperative after very short periods of operation, due to corrosion of the detectors or linear heat wire. And the high ceilings and complex ceiling framework prevents the thermal detectors from being easily serviced.

The use of flame detectors, however, can provide much faster response to a fire.

By installing the flame detectors in a cross zoned configuration, the system reliability can be improved as two separate detectors need to detect the fire before any output signal is generated.

Modern flame detectors are much less prone to false alarms due to the need for detection of more than one bandwidth. The use of double or triple Infrared detectors reduces the problem of obscuration due to smoke output, or oil films on the lenses.



## Aircraft and Hangars

The Factory Mutual Loss Prevention Data, 7-93, for Aircraft Hangars, notes that tests on aircraft fuselages have indicated that an aircraft skin will fail after 45 seconds of spill fire exposure. Since the requirement of section 3-3.2 is to achieve control of the fire from the overhead system within 30 seconds, only 15 seconds is available for detection should a fuel spill ignites.

Working with the modelling program, FireCalc (1), based on a fuel spill covering 100 square feet (approx. 10 m<sup>2</sup>), (JP4 would generate around 15,000 kW to 20,000 kW heat energy (2)), and calculations were run in different configurations to highlight the temperature increase expected from a fire.

### Using the program, TOP:

---

Fire output = 10,000 kW  
Height = 30 m  
Ceiling Area = 20,000 m<sup>2</sup>  
Resultant temp = 68 °C, after 33 min (no venting)

### Using the program, PLUME:

---

Fire Output = 15,000 kW  
Height = 30 m  
Area of fire = 10 m  
Flame temp = 1,400 °C (higher than would be expected)

### Using the program, RADIAL:

---

Fire Output = 10,000 kW  
Height = 30 m  
Ceiling area = 10,000 m<sup>2</sup>  
Temperature at 6 m from centre line of plume = 62 °C in 16 min (no venting).  
Using the program, UL  
Room dimensions = 100 m x 100 m x 30 m  
Side opening = 50 m x 30 m (smaller than actual hangar)  
Time of exposure to fire = 20 min  
Fire output = 20,000 kW  
Resultant temperature = 44°C

An actual test was performed in 1983 in Hangar 1 at Singapore Changi Airport, where the temperature from a 100 sq. ft fire was measured at 30 m above the fire. The result for the test noted a “negligible” increase detected at the sensor (3).

It seems unlikely, then, that the use of thermal detection systems in such large hangars with one side open at all times would allow the operation of a fire protection system in time to save the aircraft from significant damage, or worse, from an increase of the fire to other parts of the aircraft or hangar.

# Typical Flame Detector Applications

## Aircraft and Hangars

### References

- (1) FireCalc, CSIRO Series of computer software, 1993
- (2) Measurements of Gas Velocities and Temperature in a Large Open Pool

Fire, (M.E. Schneider and L.A. Kent, Fire Technology, Feb 1989 (3)Fire Test Report, SIA 1983)

*Note: The information is contained with the Appendices of the document relating to Tyco Global Protection - Aircraft Hanger - Reference AH9)(APPE.WP-DNI.0 100496 (Proposal drafted by Tim Magee Tyco Special Products Singapore).*

### Hazards

Fires involving volatile fuel grow very quickly, making automatic intervention essential. The fire risks in hangars themselves are relatively small; it is the high value of the aircraft that makes fire protection a necessity. The volatility of aircraft fuel, the rapid turnaround of maintenance procedures and the simultaneous use of several hazardous processes make the risk of fire incidents very high.

### Detection

Detection and protection are combined and operate almost instantaneously. The detection system is designed to monitor the under-wing and under-fuselage areas of the aircraft and to trigger localized foam protection. To minimize the risk of false alarm, coincidence detection of two or more detectors is often used to confirm any fire signal received.

Multi-channel IR flame detectors, and imaged-based flame detectors are best suited to this application for the following reasons:

- (i) improved signal processing which results in high immunity to false alarms from X-Ray sources, IR sources (from heaters, artificial lighting etc) and personnel.
- (ii) generally, the increased detector range allows a more cost-effective solution to detector usage.
- (iii) installation of detector on the walls instead of the roof provides easier installation and maintenance.
- (iv) accurate location of fire events when using triangulation of imaged based detectors such as the Tyco FV300 and the ability to target extinguishment (see 6.8).
- (v) detection of multiple fire events due, for example, to several fuel spillage within the protected area, when using imaged based detectors such as the Tyco FV300.

Fig.30 shows the protection of a aircraft with 6 Tyco FV300 image based IR flame detectors positioned to provide dual detection coverage of ALL the under-wing and fuselage areas of the aircraft, thus providing for safe coincidence detection.

## Aircraft and Hangars

### Extinguishment

Overhead foam/ water deluge system: (NFPA 409, 13 and 16)	Aircraft Hanger storage and service area
Oscillating Foam Monitors: (NFPA 11)	Aircraft and Under wing Protection Total area protection
Foam water hand hose lines: (NFPA 11)	Aircraft storage and service maintenance areas
Sprinklers: (NFPA 13)	Aircraft storage and service maintenance areas
Wheeled and portable extinguishers: (NFPA 10)	Aircraft storage and service maintenance areas

## Wellhead Process Areas

Fig.31: Wellhead Process Areas

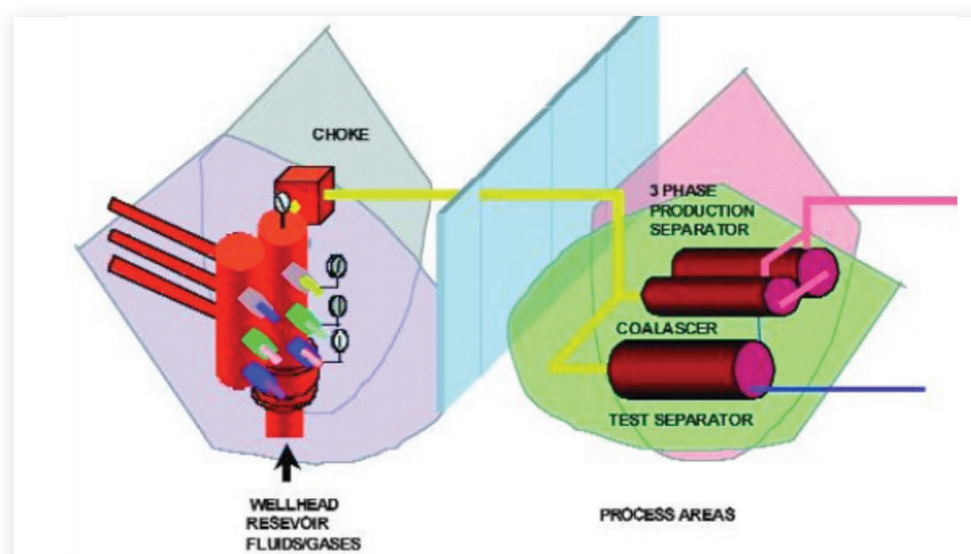

### General

The Wellhead Christmas tree assembly connects the production tubing (oil/ condensate) to the manifold for distribution to the process areas. Installed for safety purposes are an assortment of valves, gauges, and adapters. The reservoir fluid is a complex mixture of different gases, liquids and solids which represent a cocktail of flammable / combustible material with an assortment of "flash points". Fig.31 illustrates a typical wellhead process area application.

### Hazards

The process equipment, piping, vessels, flanges etc, operate under pressure. Leakage from a component constitutes a hazard with the following elements:

# Typical Flame Detector Applications

## Wellhead Process Areas

### General

The Wellhead Christmas tree assembly connects the production tubing (oil/condensate) to the manifold for distribution to the process areas. Installed for safety purposes are an assortment of valves, gauges, and adapters. The reservoir fluid is a complex mixture of different gases, liquids and solids which represent a cocktail of flammable / combustible material with an assortment of “flash points”. Fig.31 illustrates a typical wellhead process area application.

### Hazards

The process equipment, piping, vessels, flanges etc, operate under pressure. Leakage from a component constitutes a hazard with the following elements:

1. Flammable/ Combustible material
2. Pressure fed, material is already in the gas / vapour phase
3. Substantial quantities of process material are present in the system
4. Ignition could cause an explosion.

Fires in process areas can be large due to the above-mentioned points. Fuel leakage is typically caused by damage to the structure or heat metal fatigue. Such damage and fatigue is most likely to affect vessels, flange, joints, instrumentation etc;

### Processing Areas

These are defined as areas in which hydrocarbons are stored, processed and transferred and normally have an area classification of Zone 1. These include:

Wellheads,  
Crude oil gas separation,  
Compressors,  
Pumps,  
Storage vessels,  
Manifolds,  
Test areas,  
Etc.

### Detection

At least two-flame detectors should be employed, covering the hazard with a degree of redundancy. The deployment will be in the “coincidence mode”, providing a safety threshold. This is further enhanced by the use of multi channel, Infrared flame detectors, which are virtually free from false alarms.

### Extinguishment

The detection of fire or gas in a process area will initiate a series of process control shutdown events, specific to the requirements of the oil and gas.

The Fire detection may release automatic water deluge. Water deluge will provide a control burn, protecting structural metal work, process equipment and ancillaries.

The use of Foam AFFF is used to complement water deluge systems, the situation have to be assessed and a view taken with respect to extinguishing or control burning. Extinguishing the “fire” could present the dilemma of releasing quantities of unburned gas only to re-ignite again. The decision depends on whether it is safe for the fire to burn or whether the fire poses a greater threat. Generally the application of foam, is via annual means.

## Transformers

*Fig.32: Example of oil-filled transformers*



### General

Transformers are a critical link within the Power Generation of Electricity Supplies. Transformer failure can curtail power transmission lines and supplies will be out of action. The core and coils of liquid-filled transformers are immersed in a liquid. The liquids are mineral insulating oil or silicon / stabilised hydrocarbon and are flammable. The liquid serves two purposes. It is an insulating medium, and it serves to transfer heat away from the windings to be dissipated by the cooling fins, tank surface, or radiator. By using Forced-air-cooling techniques, fans are employed to assist circulation of and augment the self-cooled rating. Preservation of the liquid level is important to maintain cooling.

Typical examples of transformers are shown in Fig.32 while Fig.33 illustrates an oiled filled transformer room.

# Typical Flame Detector Applications

## Transformers

*Fig.33: Example of oil-filled transformers room*



### Hazards

The main risk with transformers is the leakage of cooling liquid. Cracked insulators and tracking to earth caused by dirt, dust, carbon deposits are possible sources of ignition.

### Detection

Rapid Flame detection is advocated. Detectors are normally configured in the coincidence mode. Cone of vision will cover the risk with a mode of redundancy.

### Extinguishment

Detection will initiate a high velocity deluge system (Mulsifyre System) which is specifically designed for extinguishing power plant equipment in:

- power stations,
- transformers,
- oil filled switch gear,
- etc.

## Transformers

*Fig.34: Example of a deluge system operated in an oil-filled transformer room*



## Robotic extinguishment

### General Principles

In the different applications considered in this section, a link has been shown between the fire hazard present, the design of the detection system (based on using sensitive flame detectors) and the choice of different extinguishing methods that may be applied.

In high risk applications where fires can develop rapidly and cause incalculable damage in human, economic and ecologic terms, it is vital that fires are detected and extinguished at the earliest possible stage of their development.

The availability of high sensitivity flame detectors which can provide location information on the detected incident, sophisticated computer based algorithms and remotely controllable suppression equipment enables the development of intelligent fire protection systems capable of rapid detection that can automatically initiate efficient fire suppression measures.

Fig.35 illustrates a typical robotic extinguishing system comprising:

- a) a pair of flame detectors, such as the FV300 IR image-based flame detector, each providing X-Y coordinates of the centre of the detected fire;
- b) computing equipment that calculate the exact location of the fire based on field configured information; and
- c) remotely controllable fire suppression equipment, such as Fire Monitors, the direction and elevation of which can be adjusted to direct a jet of extinguishing agent on the detected fire.

# Typical Flame Detector Applications

## General Principles

Fig.35: Robotic suppression system

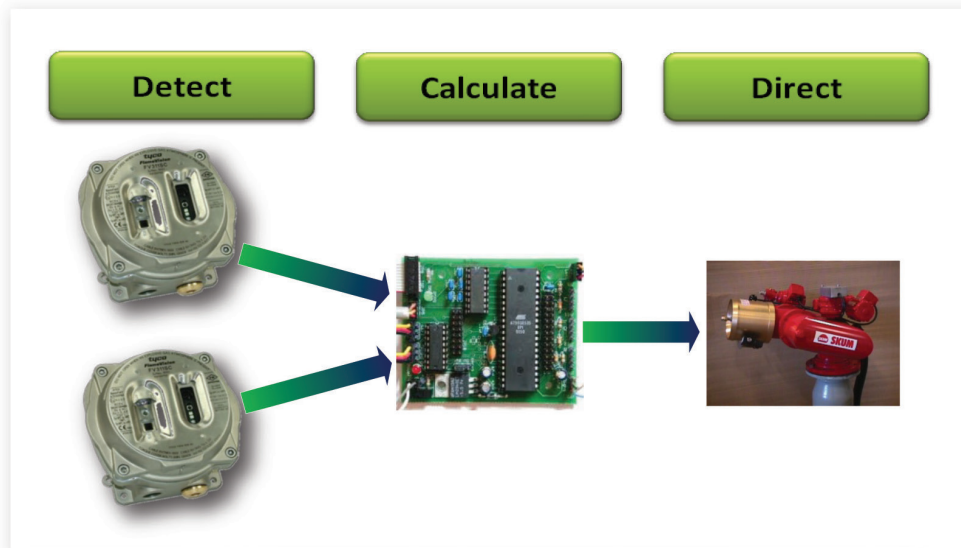

## Fire detection for robotic suppression systems

The earliest desirable detection of a potential fire incident can be achieved by sensing precursor events such as the spread of fuel vapours and flammable gases. These can include:

- fuel vapour detectors,
- gas detectors,
- oil mist detectors (in both crankcase and machinery rooms).

However, detecting these precursors do not usually provide the accurate location and size information necessary for the application of automatic fire prevention measures, except those of a general nature such as shut down of plant and machinery.

Sensitive flame detectors, on the other hand, are able to detect an early stage fire and are the ideal detection method in liquid fuel risk to provide information for activating rapid and accurate suppression measures. Available flame detectors include:

- single IR and multiple-channel IR flame detectors,
- IR flame detectors based on CCTV technology,
- image-based CCTV flame detectors,
- image-based IR array flame detectors (with or without CCTV camera).

Single IR and multi-channel IR flame detectors are designed to detect a fire anywhere within their field of view and, because of this, are not able to provide the fire location information that can be used to target fire suppression measures. This limits the use of such detectors to automated zoned suppression systems (e.g. those using sprinkler heads) where the volume covered by each detector can be defined with sufficient precision.

Flame detectors capable of analysing the image received using either CCTV technology or IR array technology or a combination of both and offering a facility to transmit data relating to the position and size of the detected event are better suited for implementing precision targeted suppression systems.



## Suppression systems

When designing a robotic extinguishing system, the following aspects need to be considered:

- the ability of the system to produce a response matched to the fire event,
- the mechanism involved in achieving the correct motion of the monitor head,
- the suitability of the extinguishing technology used for the particular fire risk,
- the minimum and maximum distance that is required,
- the mass and flow rate required for a worst case fire scenario,
- other factors such as room layout (indoors) weather conditions (outdoors).

Suitable targeting systems include:

- steerable water mist continuous jet systems;
- steerable water mist “blast” systems;
- remotely controlled firefighting monitors utilising foam;
- steerable systems using foam/water mix.

## IR array based robotic extinguishing system

The Tyco FV300 series IR flame detectors offer both the sensitivity and the fire location information required to implement a rapid response robotic extinguishing system. A data network interface, using a standard MODBUS protocol, sends information on both the X-Y coordinates of the centre of a fire event as well as the size it occupies in the field of view of the detector.

Using triangulation calculation on the information received from, at least, two FV300 detectors, a processor using bespoke software developed for this purpose can determine the exact location of the fire event and send commands to remotely direct a fire monitor at the detected fire. As illustrated in Fig.36, a third FV300 detector can be used where required to adequately cover the protected space.

In this example:

- Fires 1 and 3 are located by detectors FV1 and FV2,
- Fire 2, 4, 5 and 7 are located by a combination of detectors FV1, FV2 and FV3,
- Fire 6 is located by FV1 and FV3.

The longest detection range required from any of the detectors is less than 40 m which is within the 50 m detection range of the FV300.

# Typical Flame Detector Applications

## IR array based robotic extinguishing system

Fig.36: Triangulation of FV300 flame detectors to control a firefighting monitor

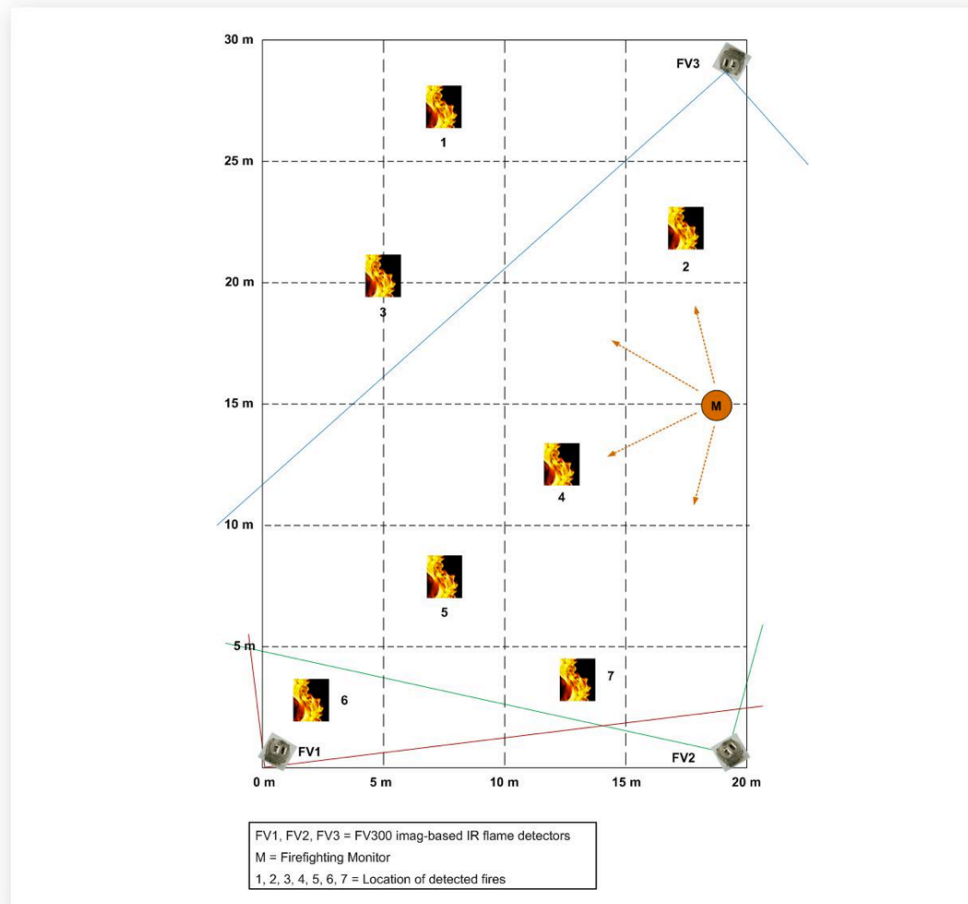

The accuracy obtained with such a system varies depending on detection range and angles but is generally accurate to within 0.5 m. With available suppression monitors, this is considered sufficient for ensuring that pool fires of 0.1 m<sup>2</sup> can be successfully brought under control.

Image-based CCTV detectors can also be used to achieve precise location of fire events and control of robotic fire suppression. However these types of detectors are less robust than IR detectors such as the Tyco FV300 series as their signal can be significantly reduced by poor lighting levels, atmospheric inhibitors such as smoke or mist or difficulties in seeing clear burning flames. By contrast, the FV300 detectors show no deterioration in signal quality as a result of either low or high lighting levels and are more resilient to the attenuating effect of ice, water, or other atmospheric pollutants. This makes the Tyco range of FV300 IR array-based detectors a prime choice for the implementation of robotic extinguishment. Fig.37 and Fig.38 shows the capture of a fire as shown by the CCTV camera integrated in the detector and the resultant IR image as obtained on the IR sensor array. Fig.39 illustrates a wood crib fire seen by the detector and the resultant extinguishment of a fire monitor directed to the fire.

Fig.37: FV300 CCTV with flame detection overlay



Fig.38: FV300 location and size information on the IR array



Fig.39: Test fire and extinguishment monitor in action



# FV300 IR Image-Based Flame Detector

## General

This section provides an overview of the FV300 IR image-based-based flame detector. Fig.40 presents a general view of the detector. The FV300 is offered in a flameproof (explosion proof) enclosure and has been designed to address many of the applications mentioned in this document and all those discussed in Section 6.

The FV300 is the latest development in a family of products started over 30 years ago, which have followed the development path highlighted in Section 4. The first products in the range were the relatively low cost single channel S100 Series of IR flame detectors which exploited Thorn Security's patented Gaussian filtering techniques to make the world's first truly solar blind IR detectors.

The S100 was developed further into the S200 dual-channel IR flame detector and then the S200 plus triple-channel IR flame detectors. The latter used a combination of advanced optical filtering and processing technologies to increase detection range and reduce false alarms from applications where blackbody radiation can cause problems.

In the years 2000s after several years of research and development in IR sensor arrays and their application to flame detection, a unique new concept of using IR image-based detection was born. The first detectors using this new technology, The FV300 was launched in 2008, after an extensive programme of tests and field trials.

What makes the FV300 unique in the field of flame detection is the use of image processing that enables the detection field of the detector to be subdivided in a number of sub-fields that can be analysed separately for the presence of real flames or non-flame events. Supplementing the IR sensor array, the FV300 comprises features taken adapted from previous ranges of Thorn Security detectors to provide immunity from a wide range of potential false alarm sources ranging from modulated solar radiation to hot and cold blackbodies.



Fig.40: FV300 Series detectors general view

## FV300 operation principles

### Key Features Overview

The FV300 offers many new features that are key to reliable performance in highly demanding industrial flame detection applications. These include:

- Advanced array based detector,
- Powerful signal processing on DSP with algorithms to give reliable flame detection,
- Detection range: over 50 m for 0.1 m<sup>2</sup> n-heptane pan fire,
- Field of view: 90° horizontal, 80° vertical, with full range maintained,
- High immunity to false alarms,
- Solar blind,
- Surveillance of protected area using built-in video camera (option), with event location identification and status overlay
- Masking of areas in field of view
- Automatic self-test of detector functions including:
  - Regular self-test of critical alarm path,
  - Window cleanliness test
- Optical alarm test at the flame detection wavelength.

### Array-Based Flame Detection

The field of view of the detector is scanned by a 16 by 16 array of highly sensitive pyroelectric sensors. A sapphire convergent lens collimates the infrared energy onto the surface of the array. A precise narrow band interference filter centred at 4.5  $\mu\text{m}$  then eliminates unwanted wavelengths.

If the signal received is of sufficient intensity to form a detectable image on several elements on the array, called a cluster, the DSP analyses their frequency characteristic as well as their correlation and spectral ratio with the signal present on the guard channel. A value representing the instant probability that a real fire is present, results from this calculation. This probability value is then analysed over a period of time to confirm whether a flame has been detected.

*Fig.41 Example of array cluster*



# FV300 IR Image-Based Flame Detector

## FV300 operation principles

### Array-Based Flame Detection

By using an array as the sensing component, the FV300 detectors are able to locate the angular position of the fire within the field of view. The detectors use this information to provide superimposed location information on a composite video output from an internal CCTV camera and to signal the coordinates of this location on its field bus data output. The array, together with its optical components and software intelligent interpolation gives the detector an angular resolution of better than 0.5 degrees.

As shown in Fig.41, array-based detection also enables the FV300 detectors to identify several separate radiation sources within its field of view. For practical purposes, the number of separate detectable sources that are reported has been limited to the four strongest, with information on these available on both video and field bus outputs.

Another advantage of array-based detection is that non-flame interferences, such as, blackbody or light sources, can be uniquely identified to within an area of the field of view. This ability to separately analyse signals from flame and non-flame sources enables array based flame detectors to not be desensitised in the presence of non-flame interferences, unless such sources are physically coincidental. It also enables a known but unwanted source of radiation that is likely to be present in the field of view of the detectors, to be ignored by applying of a 'software' mask to the signal processing but still detect fires in the rest of the area.

### Blackbody Rejection

In a new concept for eliminating nuisance alarms from modulated blackbody and other unwanted non-flame radiation sources, the FV300 employs a combination of multiple spectral analysis and time domain analysis techniques. A measure of the radiated energy in the CO<sub>2</sub> emission waveband, between 4.4  $\mu\text{m}$  and 4.7  $\mu\text{m}$ , and in a higher waveband, between 5  $\mu\text{m}$  and 5.7  $\mu\text{m}$ , provides a means to discriminate real flames from blackbodies. Unfortunately, most fuels do not have a clean burn and, except for a distinctive peak at the carbon dioxide emission wavelength, possess a characteristic more akin to that of a blackbody, exhibiting the distinctive CO<sub>2</sub> atmospheric emission band as well as a significant emission beyond 4.7  $\mu\text{m}$ .

To ensure that flames from all potential fuels are detected whilst minimising the risk of nuisance alarms, an optimum spectral signature of a flame, defined by its ratio at the two measuring wavebands (A/B in Fig. 42(a)) has been established experimentally by lighting characteristic fuels at different distances. This is compared with a similarly obtained blackbody ratio (C/D in Fig. 42(b)), enabling an optimum flame decision threshold to be defined.

In addition to the above spectral analysis, the modulated infrared energy seen by each activated cluster of the array is further analysed for frequency irregularities over a period of time that would be typical of that of a flame, but not a blackbody source. With this sophisticated level of signal processing, the FV300 range of detectors offers a high degree of immunity to all blackbody sources likely to be present in the application

Fig.42: Measured spectral characteristics of a fire and a blackbody

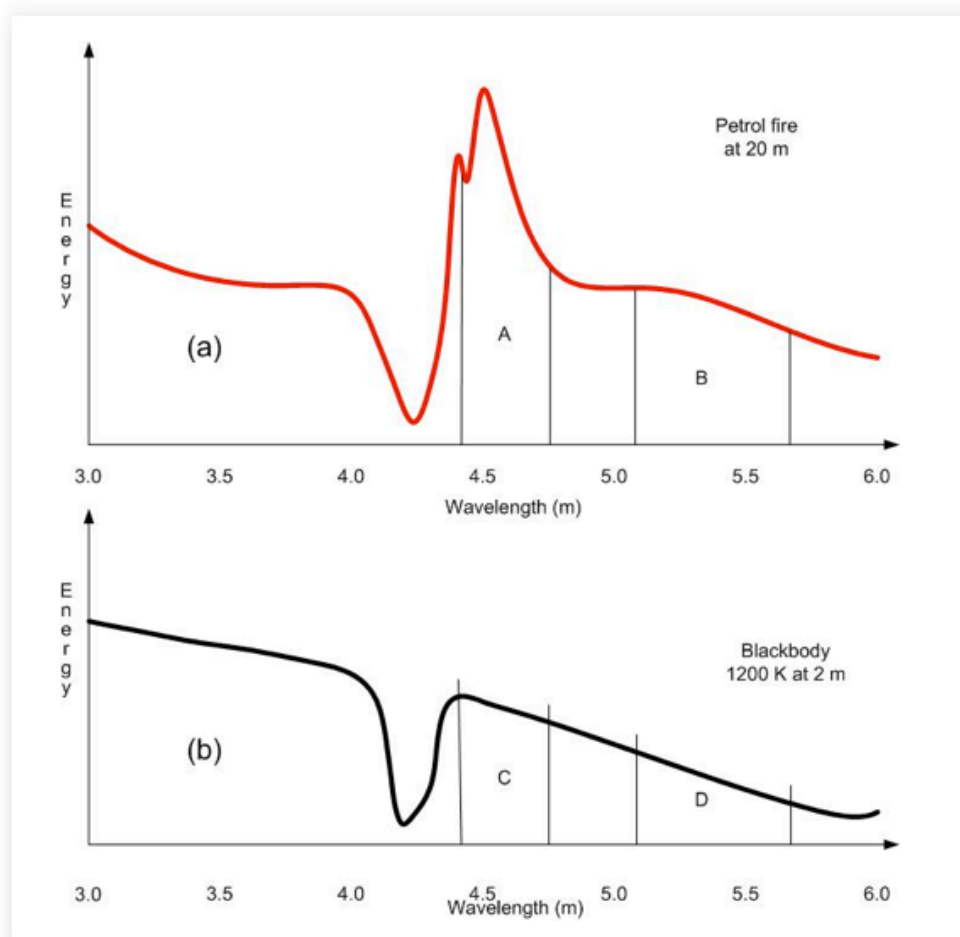

### Immunity to Solar Radiation

The FV300 incorporates an advanced method for rejecting modulated radiation from direct or reflected sunlight as well as modulated radiation from strong sources of artificial lighting based on multiple signal processing at different wavelength. First, the FV300 detector looks for the flame in a very narrow waveband where most of the sun radiation is absorbed by CO<sub>2</sub> gases in the atmosphere. Secondary re-radiation effects from sun-heated optical components is further minimised by an additional long wave IR filter on the guard channel and a special sun-block coating on the array lens.

Furthermore, the FV300 incorporates a third sensor looking specifically for radiation in the visible and short wave infrared band. The output signal from this sensor is mixed with that of the long wavelength infrared filter to operate as a spectral guard for modulated sunlight or any other strong artificial lights.

# FV300 IR Image-Based Flame Detector

## FV300 operation principles

### Detection Range

The FV300 detectors can detect a fully developed 0.1 m<sup>2</sup> n-heptane or petrol (gasoline) fire at 50 m. The collimating optics and the ability of the detector to separately process signals from individual sensing elements of the array enables the detector to correct signal losses due to off-axis incident angles. This results in a 'flatter' response throughout the detector field of view. Performance details are given in the System Design Information section.

### Multiple Fires Detection

The FV300 sensor array, together with its associated digital signal processing, can identify more than one fire event occurring at the same time within the detector field of view. At any one time, up to four alarms from the strongest flames can be reported and signalled. Fires that are sufficiently close or in the same line of sight will generate merged activity clusters on the sensor array and can only be identified as a single fire event.

### Detection of Flame in the Presence of Blackbody

The ability of the image-based detector to identify and process multiple activity clusters within its field of view allows radiation signals from fire sources and blackbody sources to be analysed separately for both their spectral and time domain signature. Thus, in the presence of modulated blackbody sources, the detector will not generally be desensitised when responding to a fire event. In some applications, unusually large blackbody sources may overshadow large areas of the field of view where detection is required. In these cases, care should be taken in the number and positioning of detectors that are needed for achieving the degree of protection required.

### Easily Installed

A separate detector base with two conduit entries and no electronics enables quick and easy phased installation. An easily located free yellow base cover seals the installation and means the detector can then be fitted closer to commissioning time in order to protect against damage

## Other FV300 Features

- BASEEFA (CENELEC) and FM certified as flameproof/explosion proof
- Meets the requirements of EN 54-10 and ISO 7240-10.
- Approval received from FM and VdS
- Submitted for DNV and LRS marine approval (with other approvals to follow)
- Variable alarm confirmation delays
- Fault and alarm conditions can be set to either latching or non-latching, in the field
- IP66/67 housing designed for external use.
- Continuous operation in the temperature range from -40 °C to +80 °C
- Supports remote led connection and remote self test initiation
- Industrial EMC protection



## Use in hazardous atmospheres

The FV300 detectors are certified 'Flameproof' to the ATEX directive and IECEx by Baseefa. They are classified as suitable for zone 1 and 2 areas over an ambient temperature range -40°C to +80°C for temperature class T135°C (T4) gasses and dust, or -40°C to +70°C for temperature classification T100°C (T5) gasses and dust. See System Design – 7.12 for certification and marking details.

The FV311 detectors are also certified 'Explosion proof' by Factory Mutual (FM) approvals. The FV311 detectors meet the requirements of FM 3600 and FM 3615 and are suitable for hazardous locations Class 1, Division1, Groups B, C and D, Class 2, Groups E, F and G and Class 3.

## Typical applications and suitable detector models

The FV300 detectors are intended for the protection of high-risk areas in which accidental fires are likely to result in flaming combustion with the production of carbon dioxide. Typical materials in this type of risk are:

- a) flammable liquids, including petroleum products, alcohol and glycol, etc;
- b) flammable gases, including methane;
- c) paper, wood, plastics and packing materials;
- d) coal;

These substances ignite readily and burn rapidly, producing flame, often accompanied by large volumes of dark smoke. Note: The detectors are not designed to respond to flames emanating from fuels which do not contain carbon, eg, hydrogen, ammonia or metals, and should not be used for such risks without satisfactory testing.

The FV300 detectors, by virtue of their construction and rejection of spurious radiation, are suitable for use indoors and outdoors in a wide range of applications. The System Design Information section gives system design recommendations and the Installation section, installation recommendations.

## FV300 Detector Variants

The FV300 detectors are housed in a rugged stainless steel enclosure suitable for harsh environments. All detectors share the same detection circuitry, optics and mechanics and the choice of two back box variants gives two basic flameproof (explosion proof) flame detector models. The FV311S series features cable gland entries and integral cable termination facility. The FV312S series features a sealed back box with cable for connection of field wiring via an EExe junction box. Each model is available in three variants depending whether the detector is fitted with an internal CCTV camera and the type of camera fitted. The range of variants includes:

- FV311S Cable entries No CCTV camera
- FV311SC Cable entries PAL CCTV camera
- FV311SC-N Cable entries NTSC CCTV camera
- FV312S Sealed back box No CCTV camera
- FV312SC Sealed back box PAL CCTV camera
- FV312SC-N Sealed back box NTSC CCTV camera

# FV300 IR Image-Based Flame Detector

## System design information

### Mechanical construction

*Fig.43: FV300 Detector – General view*

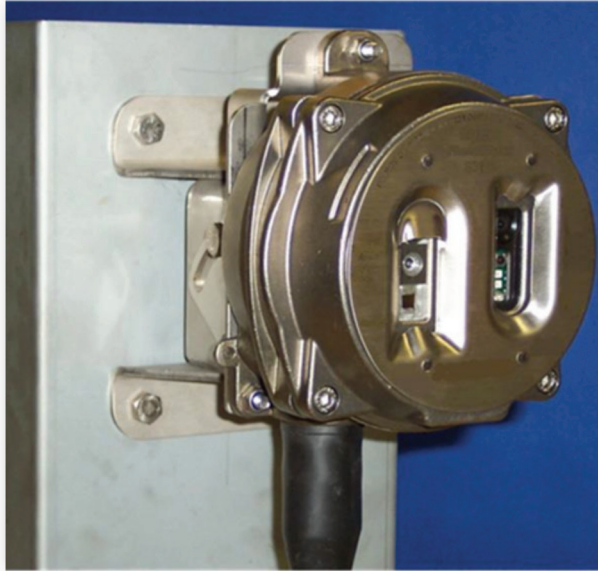

Fig.43 shows a general view of a complete detector with its mounting bracket. The detector is of robust construction to allow its use in harsh environments. The detector comprises a two-part stainless steel 'spigot-type' flameproof enclosure. Both halves of the enclosure are guided into the correct position by an alignment pin. The front section of the enclosure contains the detector optical and electronic sub-assemblies. Mating connectors at the rear of the front section and on the terminal board mounted in the rear section of the enclosure provide electrical connections to the installation cables.

The rear enclosure of the FV311 series of detectors is provided with two M20 gland entry holes at the bottom of the detector. Two 10-way terminal block arrangements are provided for termination of installation cables (see Fig.45).

The rear enclosure of the FV312 series of detectors is provided with a permanently attached cable sealed in the enclosure. With these detectors, termination of installation cables is made in an external EExe junction box (see Fig.46).

Both types of rear enclosure have a dedicated earthing point on the side of the casting (Fig. 44) to connect an earth bonding wire to the nearest safety earth. A tagging loop, also shown in Fig.44, is provided on the side of the rear enclosure to attach a suitable label to identify the detector on site.

*Fig.44: FV300 detector earth and tag fixing points*

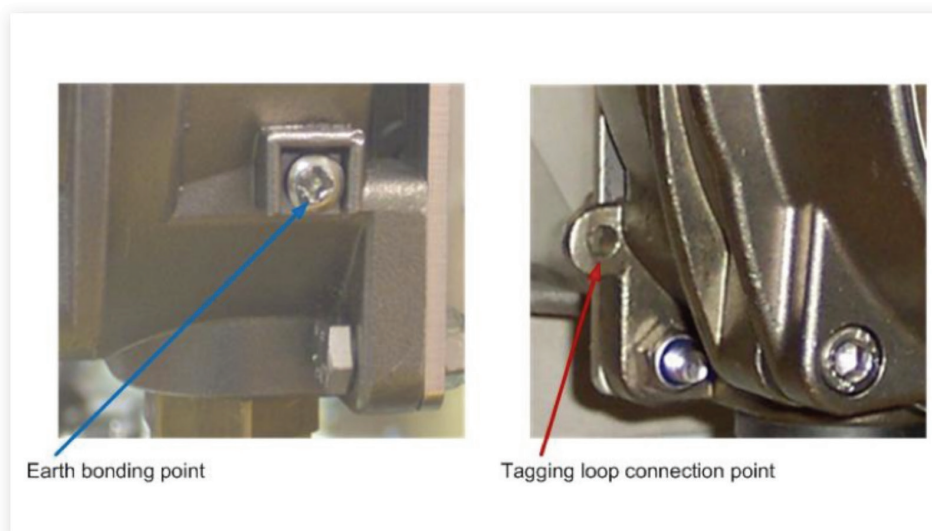

A hanging cord enables the two halves of the enclosure to remain attached when opening the detector during maintenance work.

The front section of the enclosure is attached to the rear section by four captive screws. A seal between the front and rear sections ensures protection to IP66 and IP67.

The front section of the enclosure is fitted with a window guard plate to protect the two detector viewing windows. A section of this plate acts as a mirror for the Optical Path Monitoring test. This plate also contains the mandatory markings required by the Flameproof and Explosion Proof Regulatory standards (ATEX, IECEx and FM).

The detector may be fitted directly to a suitable surface or an optional adjustable mounting bracket may be used. An optional weather hood, shown in Fig.47, is available for use where protection against extreme environmental conditions such as hot sun or downpour is needed.

*Fig.45: FV311 rear enclosure*

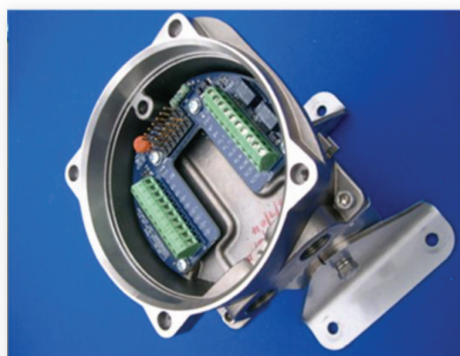

*Fig.46: FV312 rear enclosure*



# FV300 IR Image-Based Flame Detector

## System design information

### Mechanical construction

Fig.47: FV300 with weather hood



## Environmental characteristics

### General

The design and construction of the FV300 range of detectors are such that they may be used over a wide range of environmental conditions. The FV300 detectors have been designed and tested for environmental conditions and electromagnetic compatibility and comply with the requirements of:

- EN 54-10 and ISO 7240-10, European and international standards for point flame detectors;
- Factory Mutual FMRA 3260, Approval Standard for Radiant Energy-Sensing Fire Detectors for Automatic Fire Alarm Signalling;
- Lloyd's Register, Det Norske Veritas, Germanischer Lloyd Maritime Classification Societies.

### Temperature Humidity

#### FV311S/FV312S - models without camera:

---

- Operating temperature range: -40°C to +80°C
- Storage temperature range: -40°C to +80°C

#### FV311S/FV312S - models with camera:

---

- Operating temperature range: -10°C to +50°C (1)
- Storage temperature range: -20°C to +70°C

**Relative humidity (all models):** Up to 99% (non-condensing)

*(1) The FV300 incorporate a safety feature which turns the camera off in the event of the ambient temperature going outside this range while the fire detection capability remains active.*

*Vibration and shock*

## Vibration and Shock

The following maximum levels of vibration apply:

- Operational vibration: 1.24 mm displacement (from 5 Hz to 14.2 Hz)  
1.0 g (from 14.2 Hz to 150 Hz)
- Operational shock/impact: 20.0 ms<sup>2</sup>

## Electromagnetic compatibility

The following maximum levels of interference apply:

- Radiated radio frequency: 10V/m (from 80MHz to 2GHz)  
30V/m (from 415MHz to 466MHz)  
30V/m (from 890MHz to 960MHz)
- Conducted radio frequency: 10V/m (from 150kHz to 100MHz)
- Fast electrical transient burst: ± 2kV (applied for 5 minutes)
- Slow high-energy surge: ± 2.4kV
- Electrostatic discharge: ± 8kV (air discharge)  
± 6 kV (contact discharge)

The FV300 detector has also been tested for compliance with the radio frequency emission requirements of EN 61000-6-3 and, hence, meets the European Union EMC Directive 89/336/EEC. It also complies with the radio frequency emissions requirements of LRS, DNV and GL Maritime Classification Societies.

## Ionisation radiation

The FV300 detector, like other infrared detectors, is insensitive to X-rays and gamma radiation as used in non-destructive testing. The detector will operate normally and will not false alarm when exposed to this type of radiation. However, long-term exposure to high radiation levels may lead to permanent damage.

## Corrosion

The use of a sealed stainless steel 316L enclosure allows the FV300 detector to withstand the effects of most corrosive substances and gas. In particular, it meets the requirements for sulphur dioxide (SO<sub>2</sub>) conditioning in EN 54-10 and exposure to salt mist concentration as specified in LRS, DNV and GL test specifications for approval of equipment for marine use.

## Fire detection characteristics

### Fire detection range and response time

A large number of fire tests have been carried during the development phase of the FV300 range of detectors to determine its response limits. Table 6 and Table 7 show the detection range and field of view for the FV300 detectors for a selection of typical fuels. Unlike more traditional IR flame detectors, the FV300 dynamically adjusts to the fire size and does not need selectable sensitivity levels. Except for the figure marked with †These performance figures have been tested and confirmed during FM Approvals of the detector range.

*The typical response time for the detector is less than 12 seconds. The following table shows the response time for a selection of fuels measured on axis for fully developed fires. These performance figures have been tested and confirmed by FM Approvals.*

# FV300 IR Image-Based Flame Detector

## Fire detection characteristics

Table 6: Detection range over the detector field of view

Fuel	Size m <sup>2</sup> (ft x ft)	Field of view H: Horizontal V: Vertical	Distance m (ft)
n-Heptane	0.1 (1 x 1)	H = 45° V = 40°	50 (165)
Petrol	0.1 (1 x 1)	H = 45° V = 40°	50 (165)
Aviation fuel (JP5)	0.4 (2 x 2)	H = 45° V = 40°	50 (165)
Alcohol (methylated spirit)	0.1 (1 x 1)	H = 45° V = 40°	35 (115)
Diesel	0.1 (1 x 1)	H = 45° V = 30°	25 (82)
Diesel	0.1 (1 x 1)	H = 45°	24 (80)
Diesel	0.1 (1 x 1)	V = 30°	15 (50)
Methane plume	30 inches	H = 45° V = 40°	20 (64)

Table 7: Detection range over the detector field of view

Fuel	Size m <sup>2</sup> (ft x ft)	Distance m (ft)	Response Times
n-Heptane	0.1 (1 x 1)	50 (165)	9
n-Heptane	0.1 (1 x 1)	61 (200)	11
n-Heptane	0.2 (1.5 x 1.5)	61 (200)	7
Petrol	0.1 (1 x 1)	55 (180)	9
Aviation fuel (JP5)	0.4 (2 x 2)	61 (200)	9
Alcohol (methylated spirit)	0.1 (1 x 1)	35 (115)	11
Diesel	0.1 (1 x 1)	30 (100)	11
Diesel	0.4 (2 x 2)	50 (165)	7
Methane plume	30 inches	24 (80)	18

### Directional sensitivity

The FV300 detector has been designed to achieve constant sensitivity across the field of view. The relative variation of range with angle of incidence (polar diagrams) is shown in Figs. 48 and 49 for open-air tests using 0.1 m<sup>2</sup> pan petrol fires.

The continuous line indicates response of the detector within 30 seconds (as required by both FMRC 3260 and EN 54-10), with the detector at the minimum alarm delay. The dotted line indicates response of the detector within 12 seconds, for the minimum alarm delay.

*Fig.48: FV300 relative range v angle of incidence – horizontal plane*

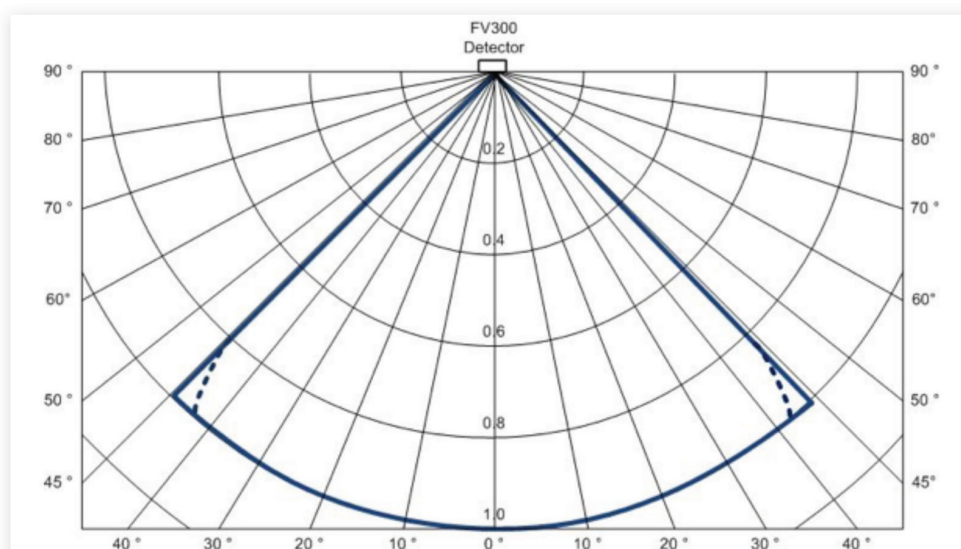

*Fig.49: FV300 relative range v angle of incidence – vertical plane*

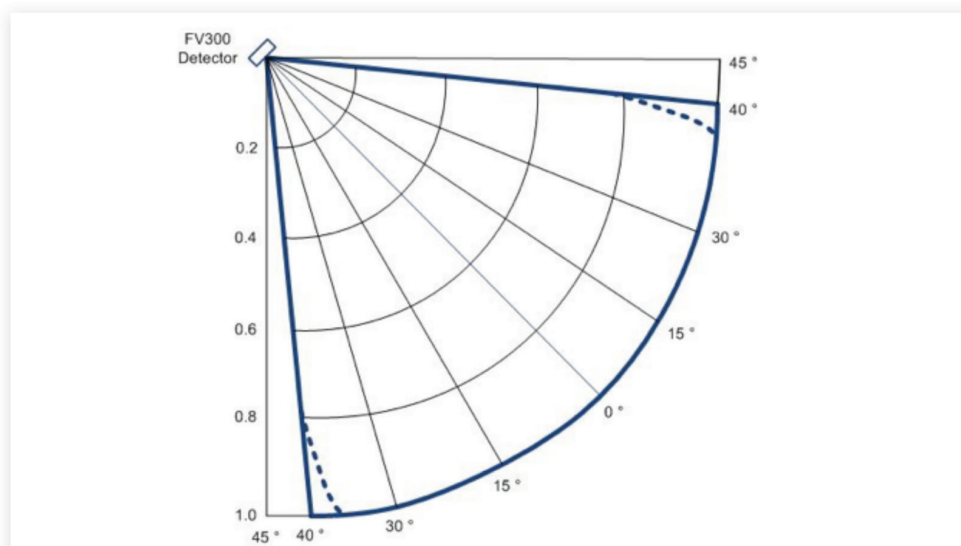

# FV300 IR Image-Based Flame Detector

## False alarm immunity

The FV300 has been subjected to sources of potential false alarms listed in Table 8. The result indicates the minimum distance at which the detector is immune.

*NOTE: Steady state sources were chopped at both regular and random frequencies in the range 0 - 10Hz.*

*Table 8: FV300 immunity response to various false alarm sources*

False alarm source	Immunity response	False alarm source	Immunity response
Sunlight	No response	125 W mercury vapour lamp	1 m
Sunlight with rain	No response	MIG welding	1 m
Car headlight (60 W halogen)	No response	2 kW fan heater	1 m
Lighted cigarette	No response	4.8 kW IR radiant heater	1 m
Grinding of ducting metal (angle grinder)	No response	2 x 500 W quartz halogen lamps (unshielded)	2 m
150 W tungsten filament lamp	1 m	Electric arc welding (2.5 mm rod)	4 m
Fluorescent bank (bank of 4 x 4 32 W circular lamps)	1 m	Car headlight (60 W Xenon)	4 m
70 W sodium lamp	1 m		

## Designing detection systems

### General

*Using the information given in 7.7.3, Fire detection characteristics, it is possible to design a flame detection system having a predictable performance. Guidelines on the application of the above data, and on siting of detectors, are given in the following paragraphs.*

*The specific conditions of each site should also be carefully assessed and taken into account at the system design stage.*



### Use of test data

It has been explained in 7.7.3 that the sensitivity of the detector is most easily specified in terms of its response to well-defined test fires. Tests are conveniently carried out using a 0.1m<sup>2</sup> pan. Sensitivity to other pan areas is estimated from field trial results.

### Determining the number of detectors

The number of detectors required for a particular risk depends on the coverage area involved and the fire size at which detection is required. Large areas or small fires require large numbers of detectors.

There are as yet no universally agreed 'rules' for the application of flame detectors and the overall system sensitivity must, therefore, be agreed between the installer and the end user. Once this agreement has been reached the system designer can determine the area covered by each detector using a scaled plot based on

Figs. 46 and 47 and the fire test data.

NOTE. This plot is best drawn to the same scale as the site plan so that direct superposition can be used to determine detector coverage.

### When designing systems the following factors should be considered:

- a) mounting the detectors on the perimeter of the area and pointing into the area will give the best coverage for area rather than spot protection;
- b) the detectors are passive devices and do not react with one another; they can therefore be positioned with overlapping fields of views;
- c) flame detectors are line of sight detectors and any object within their field of view will cause a 'shadow' in the protected area (small objects at close proximity can cause large shadows);
- d) the detector should not be mounted in such a position as to avoid water collecting on the window.

## Approvals, compliance with standards and patents

Flameproof certification

All models of the FV300 detectors are flameproof and are certified to the European ATEX Directive and IECEx by Baseefa. They comply to:

- EN 60079-0:2006
- EN 60079-1:2004
- EN 60079-7:2006
- IEC 61241-0:2006
- IEC 61241-1:2004

# FV300 IR Image-Based Flame Detector

## Approvals, compliance with standards and patents

### Certification details

ATEX Code:



Certificate:

Baseefa07ATEX0178X

IECEX/CENELEC Code:

Ex d IIC T4 ExtD A21 IP66/67 T135°C  
(-40°C ≤ Ta ≤ +80°C), or

Ex d IIC T5 ExtD A21 IP66/67 T100°C  
(-40°C ≤ Ta ≤ +70°C)

To comply with the installation condition of the flameproof certification, the FV312 must use cables suitably terminated and protected from impact.

These detectors are designed and manufactured to protect against other hazards as defined in paragraph 1.2.7 of Annex I1 of the ATEX directive 94/9/EC.

### FM Approval

The FV300 detectors are designed to comply with the requirements of Factory Mutual FMRC 3600 and FMRC 3615 for use in hazardous area locations Class I, Div 1, Group B, C, D and Class II Group E, F G and Class III.

The FV300 detectors have been designed to and comply with the requirements of Factory Mutual FMRC 3260, the performance standard for Radiant Energy-Sensing Fire Detectors for Automatic Fire Alarm Signalling.

### CSA Approvals

The FV311S, FV311SC and FV311SC-N detectors are approved by CSA for use in Canada in both gas and dust environments. They are certified:

Ex d IIC T4 DIP A21 IP66/67 T135°C; -40°C ≤ Ta ≤ 80°C

Ex d IIC T5 DIP A21 IP66/67 T100°C; -40°C ≤ Ta ≤ 70°C

CSA Certificate: 2079801

### Construction Product Directive

The FV300 range of flame detectors comply with and are manufactured to the requirements of the Construction Products Directive. Accordingly, the FV300 detectors carry the CE Mark:



0786

Certificate of Conformity: 0786-CPD-20929

## Makings and labeling

All the markings required by the various approval bodies are on the front plate (see Fig. 50) with the exception of the year of manufacture which is on a label affixed to the rear of the front case and the VdS EN54-10 approval which is on a label affixed to the back box.

Fig.50: View of FV300 label with Regulatory Markings

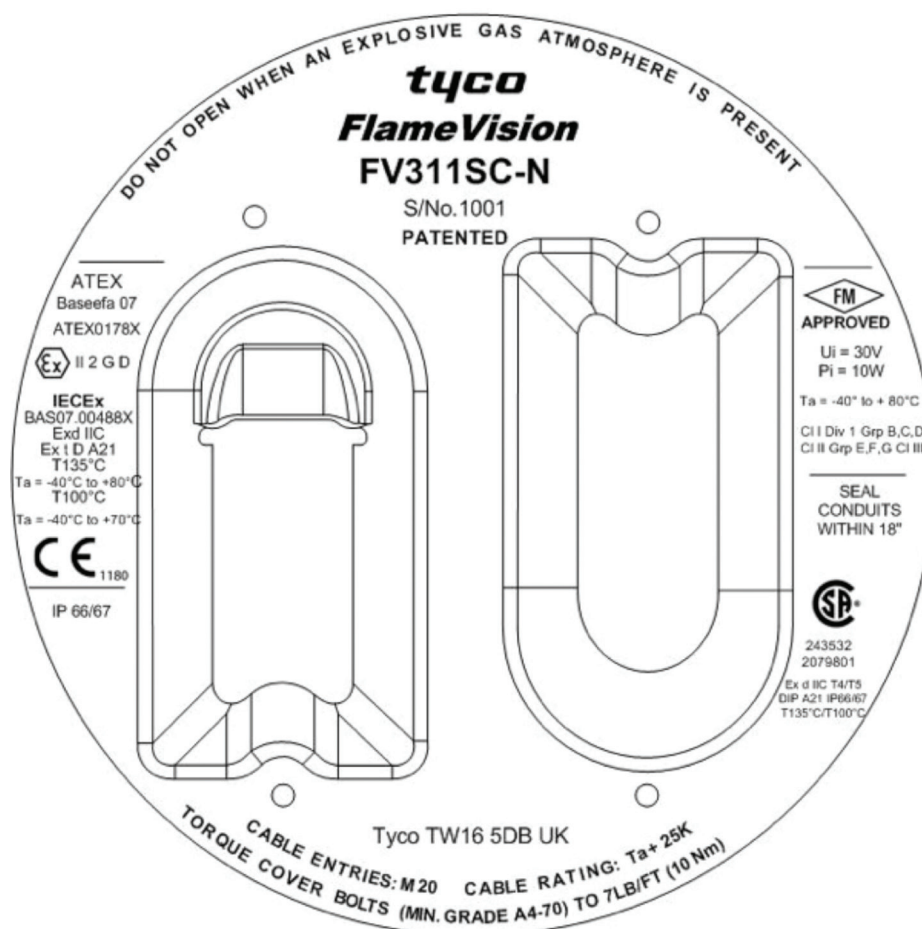

## Patents

The design and manufacture of the FV300 range of detectors is subject to the following patents:

**UK patents:** GB 2 353 856, GB 2 353 424 and GB 2 372 317

**European patents:** EU 1 079 349 and EP 1 233 386

**US patents:** US 6 528 788, US 6 476 859 and US 6 818 893

**Hong Kong patent:** HK 1 050 951

Other patents applied for.

## FV300 IR Image-Based Flame Detector

### System design information

#### System interfaces

Fig.51: FV300 system interfaces

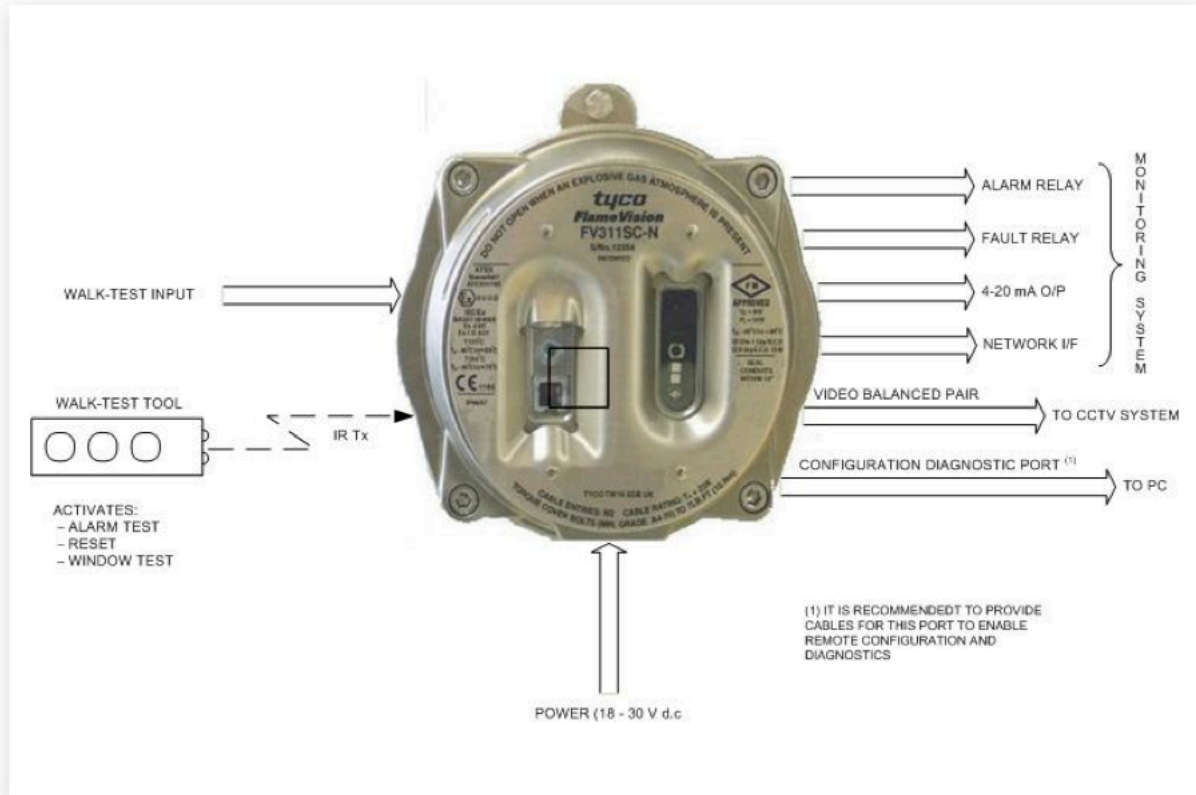

### Electrical characteristics

#### General parameters

Supply Voltage:	20 V to 30 V d.c.
Power:	up to 10 W (depending on model)
Quiescent current:	
- no camera fitted:	158 mA at 24 V
- with camera:	196 mA at 24 V
Alarm current:	
- no camera fitted:	166 mA at 24 V
- with camera:	205 mA at 24 V
Additional current when using 4 to 20 mA output in source mode:	
- quiescent condition:	4 mA at 24 V
- alarm condition:	11.5 mA at 24 V

Fig.52: FV300 4 - 20mA current sink/source wiring diagrams

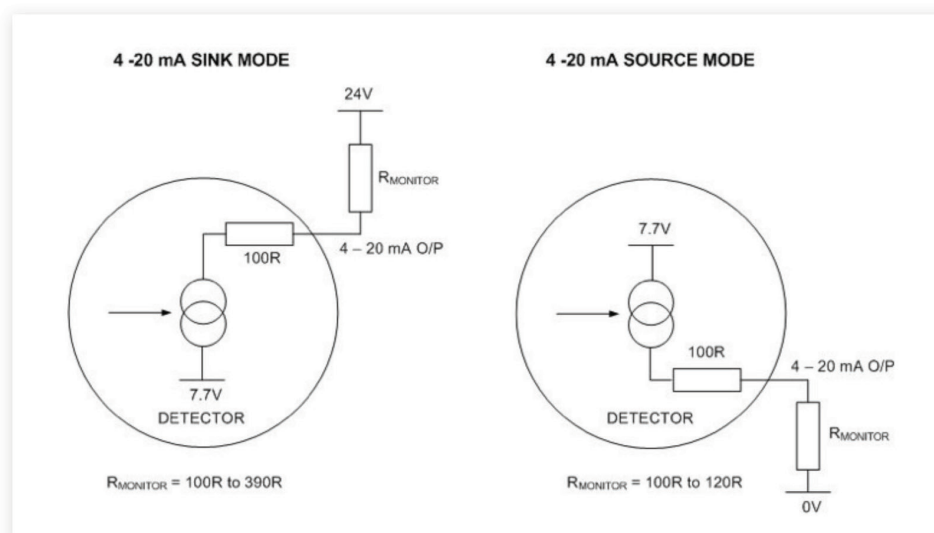

### MODBUS network interface

The FV300 can be a slave RTU device on a MODBUS network using a standard RS485 electrical interface.

#### a) MODBUS communications parameters

- Baud rate: 9,600 or 19,200 selectable
- Maximum number of units: 32
- Protocol: MODBUS Application Protocol Specification V1.1
- Mode: RTU

#### b) MODBUS Line termination

The MODBUS network should have 390  $\Omega$  bias resistors to give defined voltage levels on the line and a 220  $\Omega$  matching resistor fitted near to the controller, as shown in Fig. 53. In addition, a 220  $\Omega$  termination should be fitted at the end of the cable pair to give reliable operation, especially with long cable runs.

# FV300 IR Image-Based Flame Detector

## System design information

Fig.53: FV300 MODBUS line termination

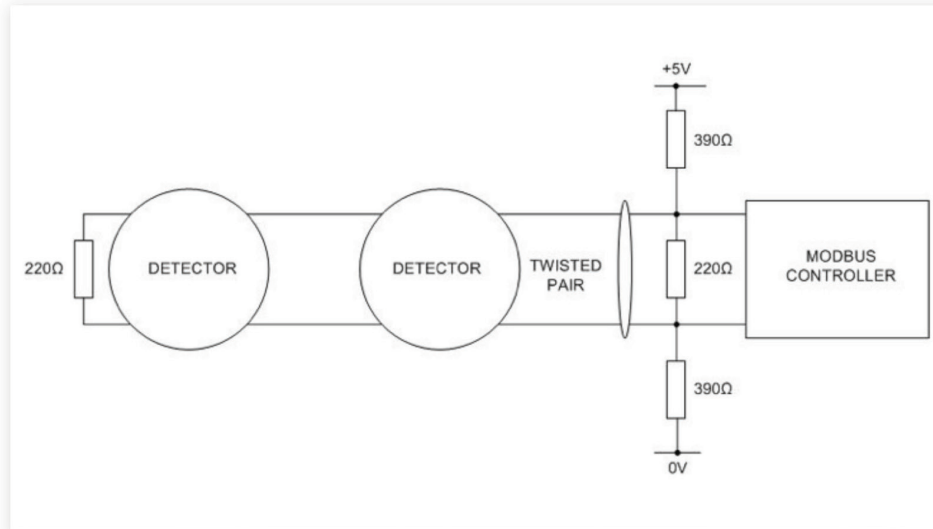

### Video output

The FV300 provides a video output from the optional internal camera for connection to CCTV systems. It is available in either PAL or NTSC format (option). The detector superimposes an overlay with status information on top of the picture to notify alarms, including location, and faults.

The video output can be used on units without a camera to display the status information overlay on a CCTV system. The status information is displayed on a coloured background. The output is enabled by configuration.

The video output is a balanced signal suitable to drive twisted pair cable. The cable should be terminated in a balun to provide the connection to the video system.

The video output operates over a reduced temperature range from -40 to +70°C. The detector controls the video output to prevent damage if the temperature goes outside the range. See Table 9. The video output has the following parameters:

**Output impedance:** 100 Ω into 100 Ω twisted pair  
**Receiving end:** Active balun NV – 652 W

A 24V supply, isolated from the detector supply if the RS485 option is used, is required. The balun connection to ground is left open.

Table 9: Video output against temperature

From (°C)	To (°C)	Text overlay on picture	Video camera	Video output
+ 70	+ 80	OFF	OFF	No video signal
+ 50	+ 70	ON	OFF	Overlay with blue background
- 10	+ 50	ON	ON	Camera or blue background with overlay
- 30	- 10	ON	OFF	Overlay with blue background
- 40	- 30	OFF	OFF	No video signal

*NOTE: The detector monitors the internal temperature to decide when to switch the video output mode. The temperatures in the table are external temperatures and vary depending on the environmental conditions and whether the window heater is enabled.*

### Window heater

The FV300 has a heater to warm the sensing window and prevent misting. The heater is enabled on the DIP switches. When enabled, the heater will turn off when the detector temperature rises above + 40° C

### Walk test input

The walk test input provides a means to connect remote switches to the FV300 detector to activate the alarm test and window test (OPM) functions or to reset the detector. The required operation is selected by connecting the appropriate resistor value; see Fig.54, between the walk test input and 0 V using a momentary switch. The switch should be opened once the function has been activated.

Fig.54: FV300 Walk test input connection

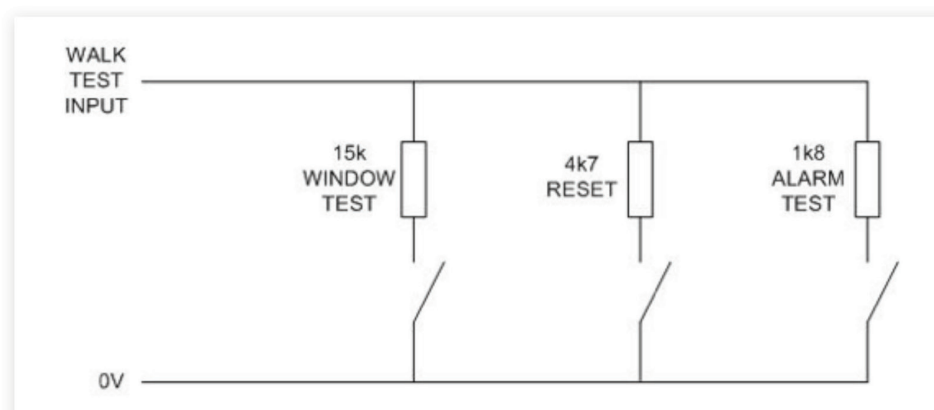

# FV300 IR Image-Based Flame Detector

## System design information

*NOTE: The FV300 detectors are approved for use in both gas and dust atmospheres but the WT300 Test tool is only approved for gas atmospheres. Where FV300 detectors are installed in dust risk environments the walk-test wired input should be used.*

### Remote LED indicator

An external LED indicator can be connected to the detector. The output follows the indications of the alarm LED. The connection is shown in Fig.55 follows:

*Fig.55: FV300 Remote LED wiring diagram*

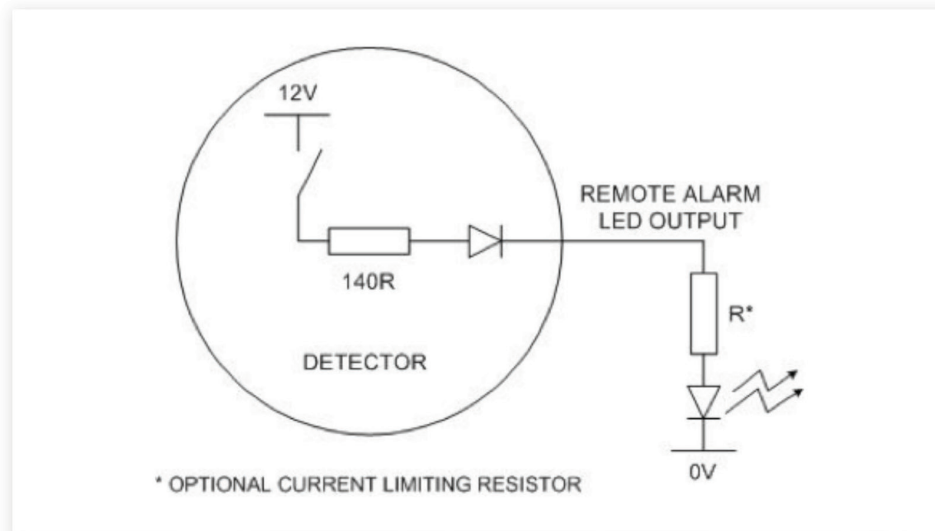

*Note: The external LED output is for visual indication only. It is intended for signaling alarms to other equipment.*

## Fire positioning solutions

### Introduction

A system for identifying flame incidents and providing targeted extinguishment by positioning fire monitors using FV300 FlameVision image based IR flame detectors and direction controllable fire monitors is available from Tyco. The system is capable of combining up to eight FlameVision detectors to create coverage zones for each fire monitor.

### Location identification principle

The information received from a pair of FV300 detectors is used by a controller to calculate the X, Y and Z coordinates of the fire incident. Fig.56 illustrates how the location of a flame is calculated using distance and angular information provided by the FV300 in a specific installation.



Fig.56: 3D representation of flame position

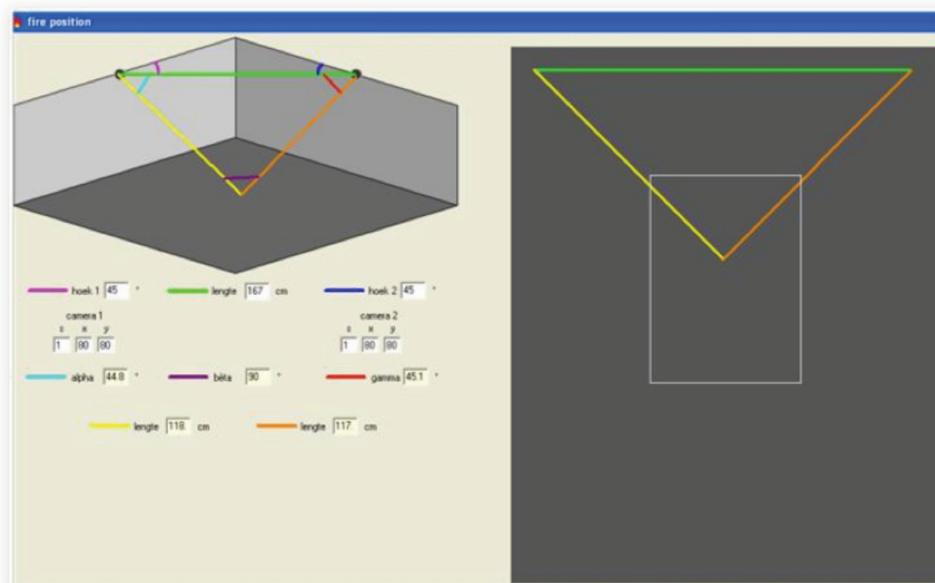

### Positioning system components

Fig.57 shows an overall Fire Positioning system integrating various components that are used in an incident monitoring, location and suppression system. Communications between the various components can be hard-wired or use data transmission protocols on Modbus, Profibus or Ethernet. The basic positioning system

includes the following components:

- Tyco FlameVision image-based IR flame detectors connected via Modbus
- Position controller with Human-machine Interface (HMI);
- Programmable Logic Controller (PLC) with controls and indicators panel to control the automatic or manual monitor movements;
- Software to programme system parameters;
- Motor Control Centre (MCC) required to control the fire monitors;
- Fire monitors such as the Tyco Fire Suppression SKUM Monitors.

The following optional equipment can be added to enhance the functionality of the system:

- Wireless Remote Control (EEEXd)
- Local operator desk;
- CCTV camera, video monitors and DVR
- Remote communication network

## FV300 IR Image-Based Flame Detector

### System design information

Fig.57: Example of fire positioning system components

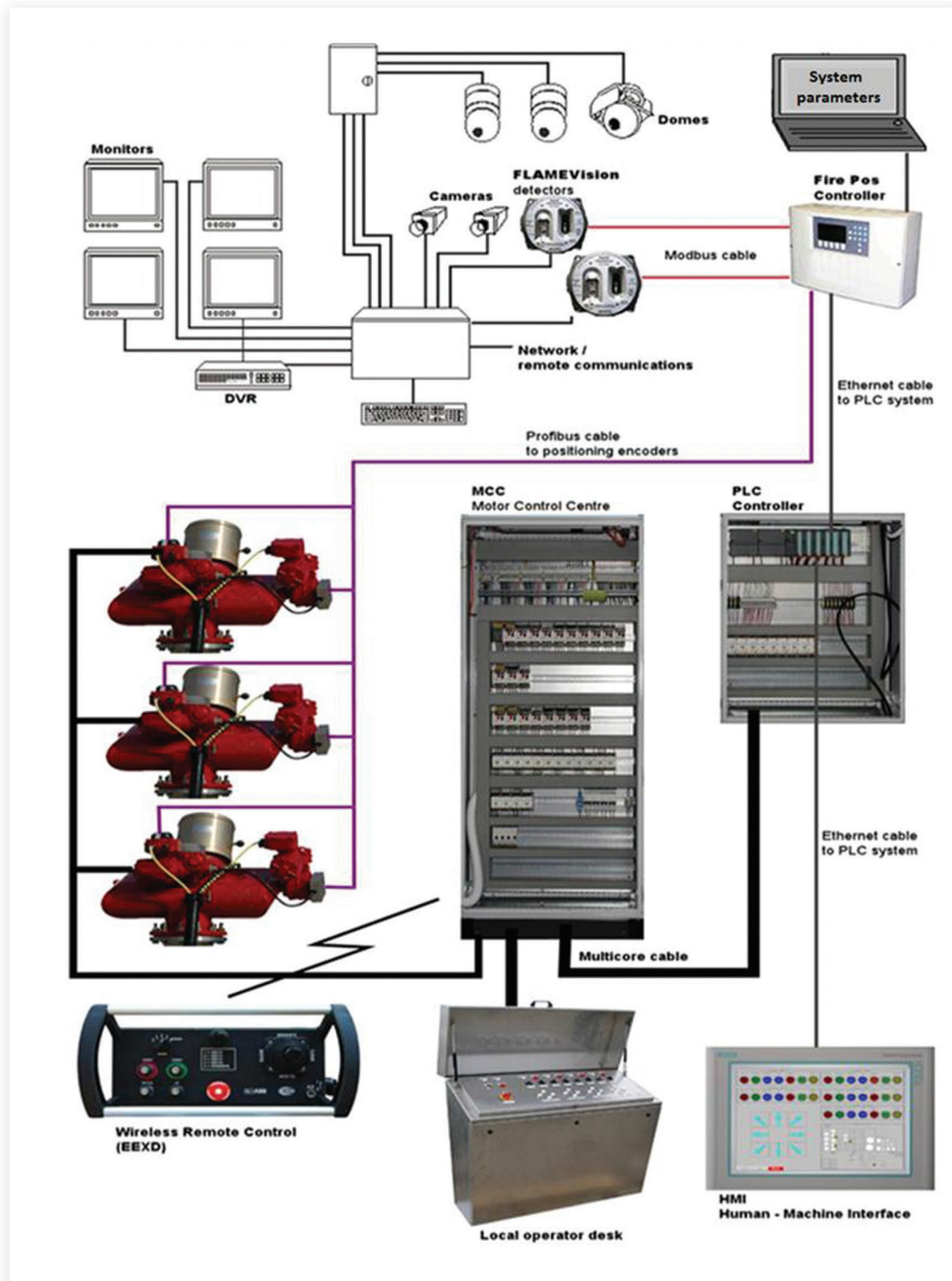

### Fire monitors

Fire monitors from SKUM, a Tyco Fire Suppression and Building Product Company, are suitable for use with the Fire Positioning system. They are designed for an optimised delivery of water or foam from a solid jet to a fog pattern by remote control. Some SKUM fire monitors are illustrated in Fig.58.

The Fire monitors from SKUM are compliant with EN 13565-2 and have received approval from:

- Det Norske Veritas (DNV)
- Lloyds Register of Shipping (LRS)
- Bureau Veritas (BV)
- China National Test Centre (TFRI)
- Russian Maritime Register of Shipping (RMRS) [type FJM-100EL]
- Russian State Academy [type FJM-100EL]

*Fig.58: Examples of SKUM fire monitors*



**FLAME***Vision*

Tyco Safety Products  
Durham Lane  
Letchworth  
Hertfordshire  
SG6 1BE  
Tel: +44 (0) 1462 667 700  
Fax: +44 (0) 1462 667 777

© Thorn Security Limited 2011  
TYMENFDAM 07/12

The right is reserved to modify or withdraw any product or service without notice.



**tyco**